

Terms & Conditions

NET 30: On approved credit only. 1½% interest charged per month on all past due invoices. New orders will be held on accounts over 45 days old (15 days past due). Open account status cancelled on accounts over 90 days old (60 days past due).

C.O.D.: Cash, check or credit card (visa or master card) required when ordered is placed, unless other arrangements are made in advance. Checks over \$200.00 are required to be verified for sufficient funds. A cashier's check may be required on substantial orders.

C.O.D. CASH ONLY: Cash or cashier's check is required on distributors/dealers with bad credit history or a past check with insufficient funds. \$25.00 charge on bad checks.

CREDIT CARD CHARGE: Visa or Master Card accepted on C.O.D. accounts. Open accounts can choose to pay by credit card on or before date of shipment only (all terms discounts will be disallowed).

WIRE TRANSFERS: Instructions will be provided upon request.

PRICING/TAX: Pricing: As published at time of shipment. All prices subject to change without notice. Non-Taxable Sales: Resale Card, Certificate of Export and/or Government Purchase Order required for all non-taxable sales.

FREIGHT: All orders are shipped F.O.B. Redlands, California. All shipments are shipped freight Prepaid and Add by our preferred carriers. Ship to address must be specified before an order can be processed. Qualified free freight orders must ship to a single distributor location. Claims for losses or damage in transit must be made with the carrier by the distributor. If merchandise arrives damaged, sign appropriately (note damage clearly on bill of lading). Shortages from Hydro Tek must be reported within 10 days of receipt of shipment. Will calls must be specified at time of order. Factory pickups available only to authorized Hydro Tek distributors with valid CA resale card. Uncrating and preparation service available at an additional charge.

MINIMUM ORDER: A small handling charge will be added to orders less than \$50.00 net.

RETURNS: Goods returned for credit must be pre-approved with a Returned Goods Authorization number by Hydro Tek and sent prepaid. All goods returned for credit are subject to a 15% restocking fee.

BUSINESS HOURS: 7:30 A.M. - 4:00 P.M. Pacific Time (Monday - Friday)

CORPORATE OFFICE: 2353 Almond Avenue, Redlands, CA (909) 799-9222 or (800) 274-9376 Order Fax (877) 477-0717

Possession of this catalog does not imply the right to purchase



The Hydro Tek Difference

Look for the **Hydro Tek Certified** seal to indicate these parts conform to the strict standards of quality & reliability we require to be on Hydro Tek equipment and are backed by our ISO9001:2008 quality management program.

TABLE OF CONTENTS

GUNS, LANCES & WASH POLES... 1	ACCESSORIES..... 16, 18
UNLOADERS, VALVES, GAUGES... 2, 3	RECLAMATION..... 16, 17
NOZZLES & CHEMICAL SPRAYER. 4, 5	SUMP PUMPS..... 17
HOSES & QUICK CONNECTS..... 6	HOSE REELS & SWIVELS..... 18
ELECTRICAL..... 7, 8	MISCELLANEOUS..... 19
BURNER PARTS & COILS..... 9, 10, 11	TRAILER PARTS..... 19
DRIVE COMPONENTS, MOTORS.... 12	PUMPS..... 20
ENGINES, ENGINE PARTS..... 13	PUMP PARTS..... 21
TANKS & FITTINGS..... 14,15	NOZZLE CHART..... BACK COVER

Brilliant Design, Tough on Grime

HYDRO TEK
CLEANING EQUIPMENT MFG.

GUNS AND LANCES



Suttner ST1500H
VG100 / 201500751
low pressure 10.5gpm
300F



Suttner ST1100
VG180 / 201100510
3000 PSI 7gpm
300F



Suttner ST1500
VG200 / 201500510
5000 PSI 12gpm
300F



call for qty
discount



GP YG5000
VG500 / YG5000
5000 PSI 12gpm
300F



Suttner ST2605
202605600
5000 PSI 7gpm
300F

All above guns are 3/8" F Inlet 1/4" F Outlet

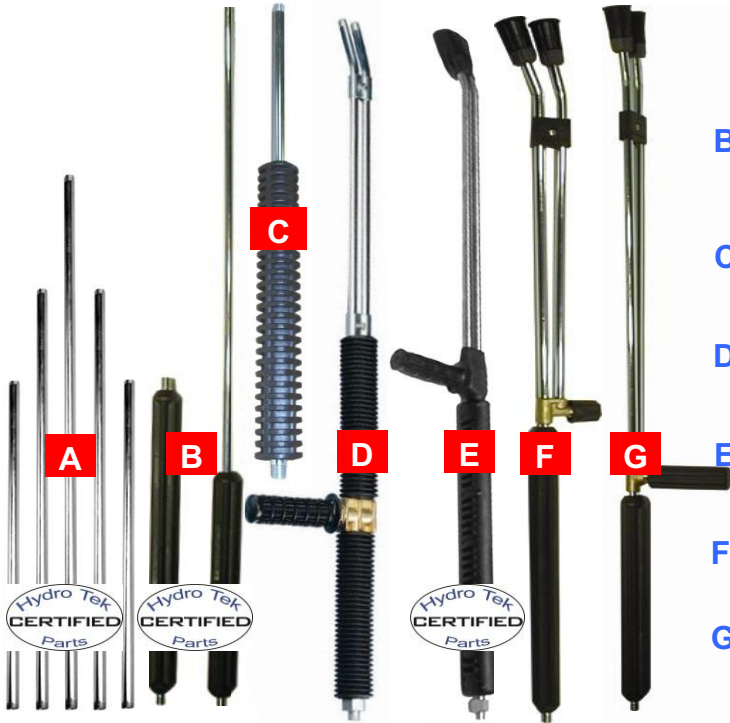

- A Suttner Zinc Plated Lance**
6000 PSI 10.5 GPM
24" VW026 36" VW038 48" VW048
- OEM Stainless Steel**
24" VW027 36" VW035
- B Suttner Molded Grip Lance**
6000 PSI 10.5 GPM 300 F
24" 070000180 36" VW036 48" VW045
60" 070000220 79" 070000230
- C AR Molded Grip Lance**
5000 PSI 10.5 GPM 302 F
24" AL323 36" AL324 48" AL325
- D GP ZZDBL**
3000 PSI / 284F / 36"
P/N ZZDBL
- E OEM Stainless Steel**
4100 PSI / 300F / 42"
P/N VWD42 / 8107.1101.00
- F Suttner ST53**
4000 PSI / 300F / 38"
P/N VWD30 / 200053500
- G Suttner ST54**
4500 PSI / 300F / 38"
P/N VWD40 / 200054500



Wash Brush / Pole
Soft hog hair bristle brush on
6' long pole. (Additional 6'
pole sections available)
P/N AVW6B

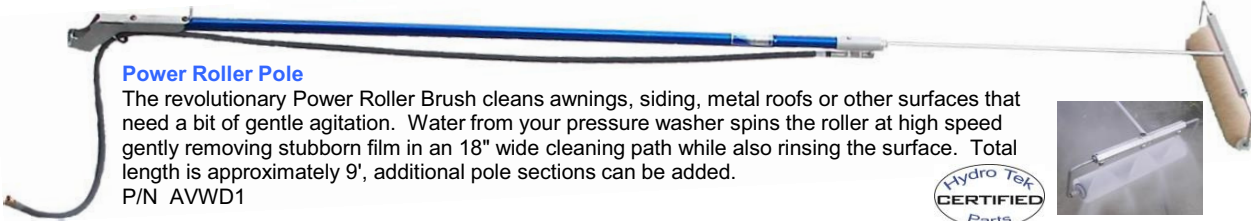

Power Roller Pole

The revolutionary Power Roller Brush cleans awnings, siding, metal roofs or other surfaces that need a bit of gentle agitation. Water from your pressure washer spins the roller at high speed gently removing stubborn film in an 18" wide cleaning path while also rinsing the surface. Total length is approximately 9', additional pole sections can be added.
P/N AVWD1



The highest rated, best equipped Wash Extension Pole on the market

The Hydro Tek 20 foot wash extension pole system offers additional features and rigidity not found with other telescopic or extension wands. This package includes a comfort brace gun holder, shoulder harness, 19' jumper hose, three sections of 6' poles, and spray head attachment. Max ratings: **4500PSI / 250F**. Designed to accept Suttner ST1500 or Hydro Tek VG200 trigger gun. Gun and twist coupler (AVGH0) not included. P/N AVW20



No need to turn off power washer to change wands, trigger gun from pressure washer snaps easily into gun bracket. (Fits Suttner ST1500 or Hydro Tek VG200 guns)



Hydro Tek Undercarriage Wand For removing dirt and grime from underneath a vehicle, try Hydro Tek's undercarriage wand with casters. Simply attach the wand to your power washer gun, insert QC nozzle and roll under vehicle. The undercarriage wand is also ideal for cleaning under boat trailers and motor homes.
P/N AVUN1



UNLOADERS / VALVES / GAUGES

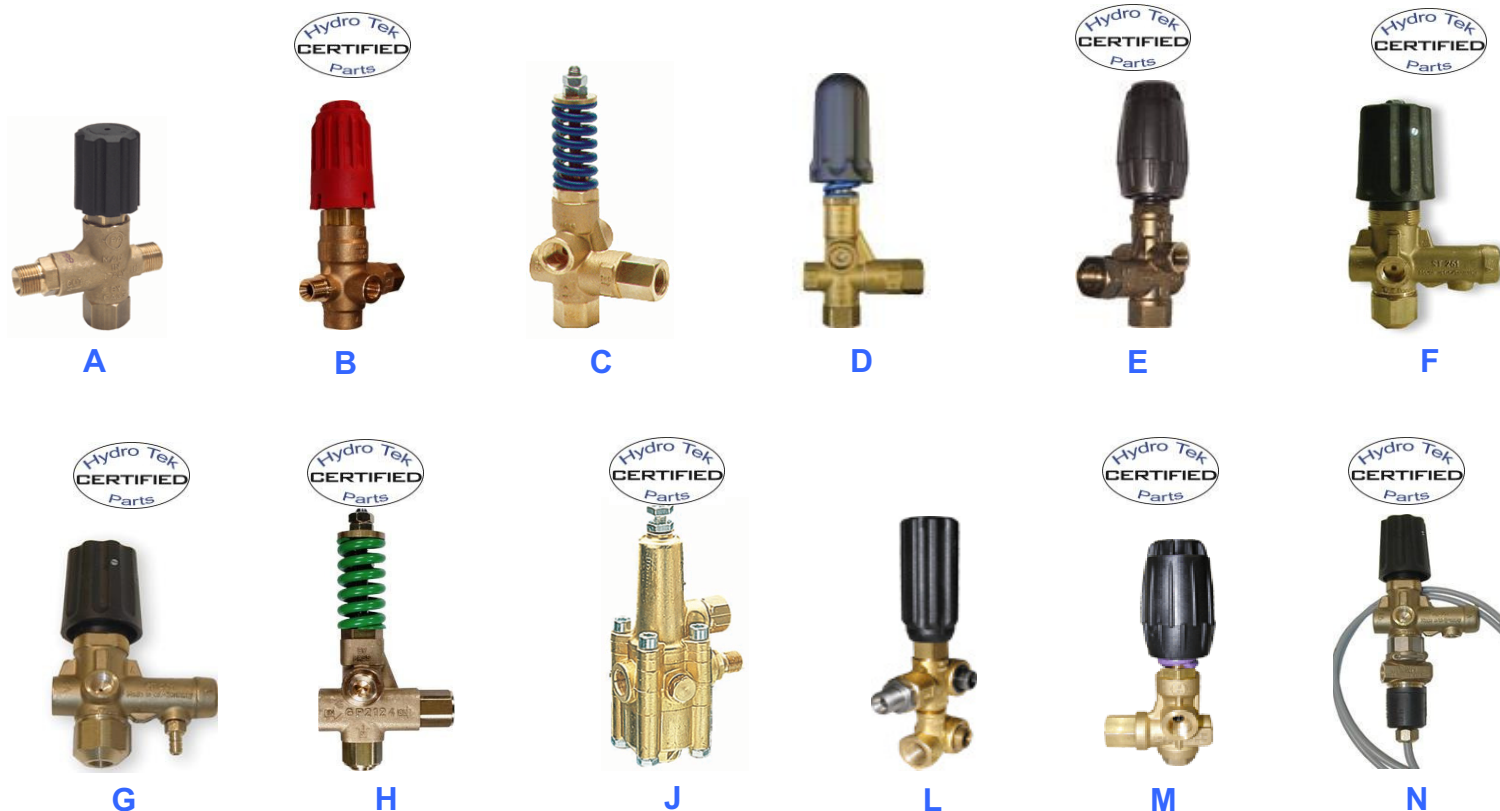

FIGURE	PART #	PSI	GPM	HT P/N	INLET	OUTLET	BYPASS	NOTES
A	YVB130	2600	6.5	UU154	3/8M	3/8M	3/8F	
B	YU5075K	5100	10.5	UU507	3/8M	3/8F	1/2F	Pressure Sense
C	YU831D	3650	8		3/8F X 2	3/8F	3/8F	Multiport
D	PULSAR4KHP	4050	10.5		3/8F	3/8F	3/8F	Pressure Sense
E	VRT3-250	3650	8		3/8F X 2	3/8F	3/8F	Multiport
E	VRT3-310	4500	8	UU323	3/8F X 3	3/8F	3/8F	Multiport
F	200261500	3600	8	UU260	3/8F	3/8F	1/4F	Pressure Sense
G	200261580	3600	8	UU263	3/8F	3/8F	1/4F	With injector
H	YU2140	4060	21	UU320	1/2F X 2	1/2F	1/2F	Pressure Sense
J	ZK70	3500	2.1-3.0	UU370	3/8F	3/8M	3/8M	Flow-Sensitive
J	ZK71	3500	3.0-4.2	UU371	3/8F	3/8M	3/8M	Flow-Sensitive
J	ZK72	3500	4.2-6.6	UU372	3/8F	3/8M	3/8M	Flow-Sensitive
J	ZK72	3500	4.2-6.6	UU375	3/8F	3/8M	3/8M	Flow-Sensitive
J	ZK73	3500	6.6-10.8	UU373	3/8F	3/8M	3/8M	Flow-Sensitive
L	AR21669	4000	5		1/2F	3/8M	Internal	XM / RK
M	MV540	2600	8	UU268	3/8F	3/8M	3/8F	With Switch
N	200261550	3600	8	UU261	3/8F	3/8F	1/4F	With Switch

Don't be fooled by imitations... Only genuine General Pump ZK7 series unloaders are rated for 3500 PSI.

UNLOADERS / VALVES / GAUGES



Safety Relief Valves

6.0 GPM / End discharge 3/8" MPT
 2000 PSI P/N UP120
 2800 PSI P/N UP128
 3700 PSI P/N UP137
 4500 PSI P/N UP045
 6000 PSI P/N UP060



Burst Disc 8000 PSI

8000 PSI Rating / Adaptor has 3/8" MPT.
 13/16 thin walled socket is required to
 change disc. **Torque to 32-42 ft/lbs**
 8000 PSI Disc P/N UPB80
 Disc Adaptor P/N UPB05
 Assembled P/N UPB85



Easy Start Valve

3/8 MPT Inlet / 1/4" discharge barb
 5000 PSI / 5.0 GPM Max
 P/N VA010 / AR4000-1



Pump Thermal Valve

145F 90 Degree 1/4" discharge barb
 3/8" MPT P/N UPT45 / 100557
 1/2" MPT P/N UPT46 / 100558



Check Valves Stainless Steel 195F Max F x F

S/S 1/4" 5800 PSI P/N VR065
 S/S 3/8" 5800 PSI P/N VR068



Adjustable Downstream Injector

4000 PSI Max 1/4" barb / 3/8M x 3/8M
 3.0 - 4.0 GPM P/N VC035 / MVR20021
 4.0 - 5.5 GPM P/N VC037 / MVR20023



Panel Mount Chemical Valve

Used on most Hydro Tek machines with high
 pressure soap injection. 1/4" Barbs
 P/N VVC10



Rubberized Control Knobs

Fits on 1/4" shaft and used on VVC10 (above)
 and thermostats with 1/4" shafts.
 Blue P/N ECH70
 Red P/N ECH72



Downstream Injection Kit 3.0 - 8.0 GPM

Includes injector, pickup hose, strainer, soap nozzle
 and quick connects
 P/N AC340 3.0 - 5.0 gpm
 P/N AC380 5.5 - 8.0 gpm



Chemical Filter 1/4" Barb

Used on most Hydro Tek Machines with down-
 stream injection
 P/N VF042



Chemical Filter W/Check & 1/4" Barb

Used on most Hydro Tek Machines with high
 pressure / inlet soap injection
 P/N VF045



High Pressure Steel Ball Valve

7000 PSI Max F x F Thread
 3/8" P/N FV006 / HPV600



3-Way 3/4" Ball Valve

Used on most Hydro Tek trailers to switch
 between float tank feed and bulk tank feed.
 P/N VVB38 - 3/4"
 P/N VVB39 - 1/2"



Float Valve

140 PSI Max / 140F Max
 3/8M Inlet / Includes float
 P/N VVF08



Industrial Rated Pressure Gauge

Stainless Steel Case / Glycerin Filled /
 Polycarbonate Window / 1/4MPT Bottom Mount.
 3000 PSI P/N 2141GXB3000
 5000 PSI P/N 2141GXB5000
 6000 PSI P/N 2141GXB6000



Industrial Rated Pressure Gauge

Stainless Steel Case / Glycerin Filled
 Polycarbonate Window / 1/4MPT Back Mount
 3000 PSI P/N 2240GXB3000
 5000 PSI P/N 2240GXB5000
 6000 PSI P/N 2240GXB6000



Hydro Tek OEM Gauge - PSI and BAR

Stainless Steel Case / Glycerin Filled
 Polycarbonate Window / 1/4MPT Back Mount
 Includes mounting bracket
 5000 PSI P/N UG055



Panel Mount Gauge Bracket

Use with any of the above panel mount gauges
 P/N 2440-UC



NOZZLES - See nozzle chart on back cover

SIZE	0	15	25	40	
	Red	Yellow	Green	White	
N	2.0	900020	915020	925020	940020
O	2.5	900025	915025	925025	940025
Z	3.0	900030	915030	925030	940030
Z	3.5	900035	915035	925035	940035
L	4.0	900040	915040	925040	940040
E	4.5	900045	915045	925045	940045
	5.0	900050	915050	925050	940050
S	5.5	900055	915055	925055	940055
I	6.0	900060	915060	925060	940060
Z	6.5	900065	915065	925065	940065
E	7.0	900070	915070	925070	940070
	7.5	900075	915075	925075	940075
	8.0	900080	915080	925080	940080
	8.5	900085	915085	925085	940085
	9.0	900090	915090	925090	940090
	10.0	900100	915100	925100	940100



General Pump "S" Style Nozzle
Through-Hardened Stainless Steel Orifice and Stainless Steel Housing
The "S" indicates 1/8 MPT
Add an "S" to the end of the part number listed in chart at the left. (15°, size 2.0 to 4.5)

General Pump "M" Style Nozzle
Through-Hardened Stainless Steel Orifice and Stainless Steel Housing
The "M" indicates 1/4 MPT
Add an "M" to the end of the part number listed in chart at the left.

General Pump "Q" Style Nozzle
Through-Hardened Stainless Steel Orifice and Stainless Steel Housing
The "Q" indicates Quick Connect
Add a "Q" to the end of the part number listed in chart at the left.

General Pump Low Pressure Soap Nozzles
65 Degree x 40.0 1/4M P/N 965400M
65 Degree x 40.0 QC P/N 965400Q



General Pump "Q" Style Nozzle 4-Pack
3.5 P/N 105120
4.0 P/N 105121
4.5 P/N 105122
5.0 P/N 105123
5.5 P/N 105124
6.0 P/N 105125
6.5 P/N 105126



Nozzle Grommet
Accepts standard 1/4 QC nozzles.
P/N HLB09

General Pump Variable Spray Angle & High / Low Nozzle
3650 PSI Max / 195F Max / 1/4F

P/N	Size
YHL40	4
YHL45	4.5



General Pump Adjustable Turbo Nozzle
3500 PSI Max 176F Max / 1/4F

P/N	GPM
ZROTOMAX1	2.1-2.6
ZROTOMAX2 / NR040	2.9-4.0
ZROTOMAX3 / NR055	4.2-5.5



Inline High Pressure Filter
Stainless Steel 5500 PSI / 8.0 GPM
200F Max 1/4 Female QC Inlet x 1/4MPT Outlet
P/N VF055 / 100560

Inline High Pressure Filter
Brass 5000 PSI / 8.0 GPM 200F
Max 1/4 MPT x 1/4MPT
P/N VF054 / 100622



Suttner ST357 / ST457 Turbo Nozzles
190F / Max 1/4 FPT

P/N	Size	Style	psi
200357535	3.5	ST-357	3600 psi
200357540	4	ST-357	3600 psi
200357545	4.5	ST-357	3600 psi
200357550	5	ST-357	3600 psi
200357560	6	ST-357	3600 psi
200357570	7	ST-357	3600 psi
NT040	4	ST-457	5000 psi
NT055	5	ST-457	5000 psi
200457555	5.5	ST-457	5000 psi
NT060	6	ST-457	5000 psi
NT070	7	ST-457	5000 psi



See nozzle chart on back cover



General Pump Foam Nozzle
 3200 PSI Max / 6.5 GPM 1.5 MM Injector
 and one quart tank
 P/N YLS12T
Special Order

Industrial Chemical Sprayer

The Hydro Tek low pressure chemical sprayer runs off a 12v battery or can be wired directly to a Hydro Tek skid and has a lighted on/off switch. The rugged frame can be mounted to your existing flat trailer or truckbed, or factory installed on your new ProTowWash trailer. Includes 50' braided chemical hose, spray wand and 40g chemical tank. (Low pressure hose reels are available also)
 P/N AC440



**Muck Scupper
 Sludge & Slurry Evacuation Tool**
 Turn your pressure washer into a sludge, slurry, water evacuation tool. Pressure energy of spray from pressure washer wand creates suction that pulls water, up to 87gpm, through a 15' heavy wall 1½" discharge hose. Ideal for clean out of sump pots, draining a fountain or pond, and flood cleanup.
 P/N ANS04, size 4.0
 P/N ANS55, size 5.5

Longer hose lengths available
 P/N DHB17, sold per foot



Connect to your existing ¼" pressure washer wand quick connect coupler, no other tools required.

Watch it in action at <http://www.hydrotek.us/accessories.htm>

Hydro Tek Industrial Sand Blast Assembly
 1000-4000 PSI / 158F Max
 Includes 50' of crush-proof PVC sand hose and heavy duty sand probe.
 Size 4.0 P/N ASB40
 Size 5.5 P/N ASB55
 Replacement mix noz P/N NB095



General Pump Universal Sand Blast Assembly
 1500-5500 PSI
 3-10 GPM / 200F Max. Includes 25' sand hose. Install your own 1/4" MEG nozzle to match the PSI & GPM of pressure washer being used
 P/N DWSDBTK



Hydro Tek Powder Coated Steel Sand Hopper Assembly with Heavy Duty 6500psi Carbide Sand Head

Powder coated steel, 300# capacity. Designed to mount on Hydro Tek trailers but can also be mounted to most flat trailers and truckbeds. Includes 50' of 3/4" Crush-Proof PVC sand hose, size 6.0 x 5° nozzle, 3/4" sand couplers to make a complete system. (wheel / handle kit additional)
 P/N ASH06



Wheel / handle option sold separately.

See nozzle chart on back cover

HOSES & QUICK CONNECTS

Whip Hoses 250F Max

Durable wire braided with fabric impressed cover and minimum three-times burst rating. All hoses are 3/8" MPT Rigid x 3/8" MPT rigid.

P/N	Pressure	Length	Size
DH003	4000	18"	3/8"
DH200	4000	20"	3/8"
DH026	4000	27"	3/8"
DH032	4000	30"	3/8"
DH034	4000	34"	3/8"
DH006	4000	36"	3/8"
DH007	4000	48"	3/8"
DH008	4000	78"	3/8"
DH014	5000	108"	3/8"
DH015	5000	114"	3/8"
DH020	5000	128"	3/8"



3/8" HYDRO TEK HOSE 250F Max

Durable wire braided with minimum three-times burst rating. Fabric impressed cover for abrasion resistance and longer wear. All hoses are 3/8" MPT Rigid x 3/8" MPT Swivel and include whip guards.

P/N	Pressure	Length	Size	Color
DH025	3000	25'	3/8"	Black
DH050	3000	50'	3/8"	Black
DH095	3000	100'	3/8"	Black
DH027	4000	25'	3/8"	Black
DH057	4000	50'	3/8"	Black
DH097	4000	100'	3/8"	Black
DH060	5800	50'	3/8"	Grey
DH098	5800	100'	3/8"	Grey



4000 PSI



5800 PSI



Smooth Rubber Pressure Washer Hose

50' x 1/4" M22 screw couplings and bend protectors. Max. 3000psi and 140F. For use with lighter duty pressure washers. P/N DH426



Inlet Garden Hose

100' x 5/8" Heavy duty PVC compound garden hose. Silicone-free with industrial brass fittings on both ends. P/N AG100



Bulk Clear Braided Tubing

1/4" P/N DHB04
1/2" P/N DHB08
5/8" P/N DHB10
3/4" P/N DHB12
Sold 50' Minimum



1" PVC Spring Wire Hose

Won't collapse when used as high volume supply hose. Ideal applications are machines rated 7+ GPM P/N DHB18

Bulk Black Fuel Hose

Use for Gasoline or Diesel 1/4" P/N DHP04 Surpasses CARB and EPA permeation requirements



Bulk Black Reinforced Hose

Great for water feed & bypass lines 1/2" P/N DHC80 3/4" P/N DHL12 Sold 50' Minimum

PVC Hose

The best hose we've found for sandblast applications. Smooth bore for unobstructed sand flow and thick wall that prevents collapse. 1/2" P/N DHS08 Sold 50' Minimum



Female Plug QC

1/4" Steel P/N D10006
3/8" Steel P/N D10008
1/4" Stainless P/N D10076
3/8" Stainless P/N D10078



Male Plug QC

1/4" Steel P/N D10007
3/8" Steel P/N D10009
1/4" Stainless P/N D10077
3/8" Stainless P/N D10079



Female Socket QC

1/4" Brass P/N D10001
3/8" Brass P/N D10003
1/4" Stainless P/N D10072
3/8" Stainless P/N D10074



Male Socket QC

1/4" Brass P/N D10002
3/8" Brass P/N D10004
1/4" Stainless P/N D10073
3/8" Stainless P/N D10075



Female Twist Coupler Plug

1/4" Brass P/N D10022
3/8" Brass P/N D10024



Male Twist Coupler Plug

1/4" Brass P/N D10021
3/8" Brass P/N D10023



Female Twist Coupler Socket

1/4" Brass P/N D10027
3/8" Brass P/N D10029



Male Twist Coupler Socket

1/4" Brass P/N D10028
3/8" Brass P/N D10030

O-Rings (Sold in Bags of 100)



Viton 400F 75 Durometer

1/4" Viton P/N OR-110VT75
3/8" Viton P/N OR-112VT75

EPDM 300F 70 Durometer

1/4" EPDM P/N OR-110EPDM70
3/8" EPDM P/N OR-112EPDM70



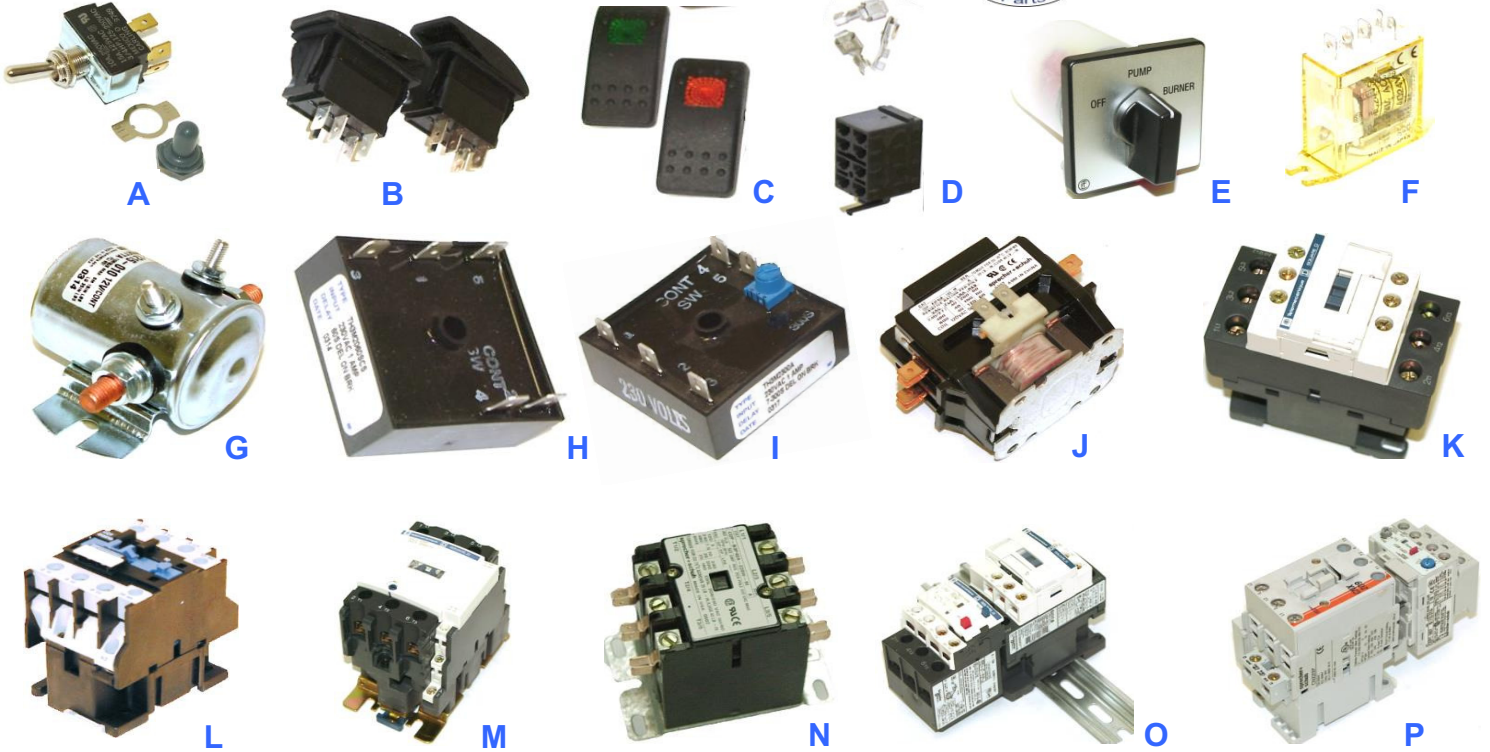

FIGURE	PART #	DESCRIPTION
A	EC110	Toggle Switch DPST 1 1/2 HP
A	EC115	On / Off plate for EC108
A	EC160	Rubber Boot for EC108
B	EC405	12 VDC Rocker Switch DPST Clear
B	EC406	24 VAC Rocker Switch SPST Red
B	EC410	110 VAC Rocker Switch SPST Red
B	EC411	110 VAC Rocker Switch SPST Clear
B	EC420	230 VAC Rocker Switch DPST Red
B	EC421	230 VAC Rocker Switch SPST Clear
B	EC450	Rocker Switch / Momentary
C	EC490	Rocker Cover Red
C	EC495	Rocker Cover Amber
C	EC498	Rocker Cover Green
D	EC499	Socket w/6 Terminals / Fits all "EC4" Series Switches
E	EC170	Rotary Switch 110 VAC
E	EC260	Rotary Switch 220 VAC
F	ECC08	24 VAC Coil Relay 7.5A 120 VAC - 7A 240 VAC
F	ECC01	110 VAC Coil Relay 7.5A 120 VAC - 7A 240 VAC
G	ECC07	12 VDC Constant Duty Relay for 12 VDC Burners 120A
H	ECD10	120 VAC 60 Second Timer
H	ECD20	220 VAC 60 Second Timer
I	ECD24	24 VAC Adjustable Timer 5 - 300 Seconds
I	ECD25	220 VAC Adjustable Timer 5 - 300 Seconds
J	ECC12	Contactator with 110v coil 1PH 40 A
K	ECC10	Contactator with 110v coil 1PH 30 A
L	ECC20	Contactator with 220v coil 1PH 30 A
M	ECC40	Contactator with 220v coil 1PH 70 A
N	ECC21	Contactator with 220v coil 1PH 40 A
O	EA053	220 VAC Starter 3PH 16-24 A
O	EA054	220 VAC Starter 3PH 9-13 A
P	EA103	220 VAC Starter 3PH 40-52 A

12VDC Burner Relay
12VDC - 70A
P/N ECC05



Circuit Breakers
1/2 AMP P/N ECF05
3 AMP P/N ECF03
15 AMP P/N ECF10
20 AMP P/N ECF15



Mini Delay Fuses
1/4 Amp P/N EF025



Honeywell Step-down Transformer
110 / 208 / 230 - 24VAC 40VA
P/N BGT10



Transformer
460 VAC - 230 VAC 50 VA
P/N ECT06



Transformer
460 VAC - 230 VAC 100VA
P/N ECT05



ELECTRICAL



Hydro Tek Certified Replacement Parts



Suttner ST-6 Flow switch
3600 PSI / 8.0 GPM / 400 VAC
3/8F x 3/8F 176°F
P/N VS006 / 200006540
With spring P/N VS007



Suttner ST-5 Flow switch
3600 PSI / 8.0 GPM / 400 VAC
3/8F x 3/8F 176°F
P/N VS005 / 200005500



Replacement Reed Switch ST5 / ST6
Replacement for both the ST5 & ST6
P/N VS003 / 200005455



Low-Flow Flow Switch 90 Degree
Adaptor required at each end
P/N VS052



Low-Flow Flow Switch Straight
Adaptor required at each end
P/N VS050



Flow switch Adaptor
3/8F P/N VS051
1/2" Barb P/N VS053



GP Thermostat 4000 PSI
86° - 194°F P/N 100438
86° - 320°F P/N 100439
86° - 250°F P/N 100538



Hydro Tek Thermostat 4000 PSI
The best, fastest responding unit on the market
86° - 250°F P/N ECH50
95° - 194°F P/N ECH55



Rubberized Control Knobs
Fits on 1/4" shaft and used on thermostats with 1/4" shafts.
Blue P/N ECH70
Red P/N ECH72



GFCI Power Cords 37' SJTW Cord
115 VAC 15A 14/3 Includes 15A Plug
P/N EP115
115 VAC 20A 10/3 Includes 20A Plug
P/N EP120
240 VAC 30A 10/3 Plug not included
P/N EP125
240 VAC 40A 8/3 Plug not included
P/N EP240



Vacuum Switch 1/4F Inlet / 140F
1.5 P/N VS012 / 8107.2211.00
2.5 P/N 8107.2213.00
4.5 P/N VS015 / 8107.2217.00



Hour Meter - Panel Mount
12 VDC P/N EM305 mechanical
110 VAC P/N EM601 mechanical
220 VAC P/N EM603 mechanical
(while supplies last for mechanical type)



12 VDC P/N EM312 digital
110 / 220 VAC P/N EM313 digital



Polycarbonate NEMA 4 Electric Box
7.8" x 4.7" x 3.2" with cover
P/N EWB06
10" x 8" x 6" with hinged cover
P/N EWB10



Battery Boxes
Small U1 P/N HB050
Large G24 P/N HB100
Large-Snap lid box P/N HB101



Strain Relief Waterproof Fittings
1/2" P/N EWC08 Nut EWN08
5/8" P/N EWC10 Nut EWN12
1" P/N EWC12 Nut EWN16



Wire Loom Sold by the Foot (10' minimum)
1/4" P/N EWL20
3/8" P/N EWL25
5/8" P/N EWL30
1" P/N EWL16

Pressure Switch 195F / 250VAC Max

FIGURE	SWITCH ON	MPT	MAX PSI	AMP / MAX	P/N
A	580	1/4	4000	15	VS030 / YPRESSWITCH
A	580	3/8	3600	15	YPRESSWITCH1564
B	650	3/8	5800	15	VS025 / YPRESSWITCHHP

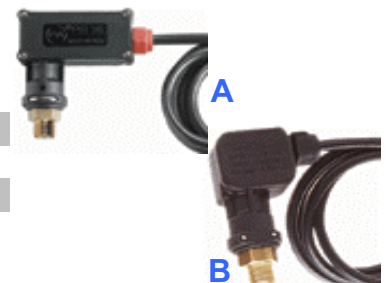

Hydro Tek Replacement Heating Coils

(please provide the model# and serial# when possible)

Listed below are the most common coil replacement part numbers. There are additional coils and coil part numbers available. Refer to the machine parts breakdown or call for assistance.



Beckett 12 VDC SDC
high output
Firing Range 1.75-5.5 GPH
P/N BU023



Beckett 12 VDC ADC
Firing Range 1-3 GPH
P/N BU013



Beckett 110 VAC SM
Firing Range 1.25-3 GPH
P/N BU600



Beckett 110 VAC AFG
Firing Range .85-1.65 GPH
P/N BU605



Beckett 220 VAC SM
Firing Range 1.65-2.5 GPH
P/N BU602



Wayne 110 VAC EHA
Firing Range 1-4 GPH
(while supplies last)
P/N BU007



4 spiral, Sch 80 x 1/2"
Fits SK Series and older SS, SC, SCU, & HP Series
P/N BC480 Coil only (16.38" x 22.25")



SpiraLast™ Heating Coils
Cold rolled and robotically fused
4 spiral, Sch 80 x 1/2" (14")
P/N BC300 Complete coil and stainless wrap assembly (fits HD Series mfg. after 2013)
P/N BC316 Complete coil and stainless wrap assembly (fits some SS Series mfg after 2014)
P/N BC144 Coil only (18.22" x 13.25")



4 spiral, Sch 80 x 1/2" (18")
P/N BC335 Complete coil and stainless wrap assembly (fits HP, SC, and most SS Series mfg. after 2014)
P/N BC484 Coil only (21.27" x 16.18")

6 spiral, Sch 80
P/N BC445 Complete coil and stainless wrap assembly (fits SCU Series mfg. after 2014)
P/N BC788 Coil only (26.75" x 16.57")

6 spiral, Sch 80
P/N BC789 Complete coil and stainless wrap assembly - Hexagonal shaped wrap (for HN Series, mfg. after 2013)

Call for availability and replacement options for coils not listed here.



Wayne Burner Parts



Blower Wheels
6 1/4 x 4.0 / 21854
P/N BM289



Wayne Burner Motors
110 VAC EH "N" Flange / 20554
1/5 HP
P/N BM554



Burner Gun
EH Series Burners / 31763-003
P/N BM018

Burner Gasket 4"
MFG P/N 14344
P/N BM017



Tune-Up Kits / Parts
Tune-up Kit M, MSR, MH, ER, ERA, AH, EHA, EHASR, OE, OEA / 31156
P/N BM156
Electrode Kit (2-included) / 13286
P/N BM161
Drive Coupler (All E-Series) / 13279
P/N BM160



Transformers / Igniter
12 VDC Igniter / 409006 / 100764
P/N BMT02
110 VAC Transformer EH / 23101-E
P/N BMT10
220 VAC Transformer EH / 23103-E
P/N BMT20



Beckett ADC 14 VDC Motor
 Replaces 21539U, 21557U, 21699U
 1/6 HP MFG P/N 21699UF
 P/N BM514



Burner Motor
110 VAC / 2456U
 1/7 HP AF / AFG P/N BM556
220 VAC / 21774
 1/7 HP AFG P/N BM562
110VAC / 2900U
 1/5 HP SM P/N BM513
220 VAC / 21173
 1/4 HP SM P/N BM563



12 VDC Igniter
 Igniter only / For ADC burner
 Custom Coils P/N 5049 / 6340
 P/N BMT04



Power Light 12VDC Igniter
 For ADC burner, includes control board
 MFG P/N 5218301U
 P/N BMT12



110 VAC / 220 VAC
110 VAC Back Mount Igniter
 MFG P/N 51772U
 P/N BMT18



Power Light 220 VAC
 Back Mount Igniter, includes control board and
 Cad Cell
 MFG P/N 5199702U
 P/N BMT13



Advanced Burner Control Module
 Safety control for burner motor. Interrupted or
 intermittent duty ignition, 15 second lockout
 time on flame failure
 110V P/N BMC15 (shown in photo)
 12V P/N BMC13

Beckett Burner Parts



Burner Gun ADC
 MFG P/N ML35XPDC
 P/N BM020

Electrode Kit (2-Included)
AF, AFG, AR, SF, SR, SM
 MFG P/N 5780U
 P/N BME10



Burner Gasket
ADC / 31332
 P/N BM030
AFG / 3616U
 P/N BM035
ADC / 3380U
 P/N BM019

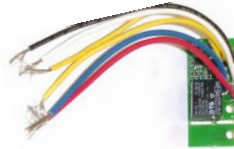

Ignition Control Board 12 VDC
 Used on 12 VDC ADC Burners (included with
 BMT12 and BMT25) to drop out the igniter after
 fuel ignites.
 MFG P/N 51663
 P/N BMC40



Cadmium Sulfide Diode (CAD CELL)
 Used in conjunction with the BMC40 control
 board to sense when the burner ignites
 MFG P/N 7006U
 P/N BMC20 (while supplies last)



Electrode Tabs
 Used on most Beckett burner electrodes
 MFG P/N 31706
 P/N BM159



Blower Wheels
4 1/4 x 2 7/16 ADC / 21404U
 P/N BM275
6 1/4 x 3 7/16 SM / 2383U
 P/N BM276

We sell many more burner parts.
Please call if you don't see what you need.

Natural Gas / Propane Parts



Ignition Wire 52"
 P/N BGW36



Honeywell Ignition Module
 90 Second Lockout 24 VAC. You may need a
 longer ignition wire (P/N BGW36) if replacing an
 older grey module.
 P/N BGG15



Honeywell Step-down Transformer
 110 / 208 / 230 to 24VAC 40VA
 P/N BGT10



Pilot Assembly
 P/N BGP10
Pilot conversion to LP
 P/N BGV09



Gas Valve 3/4" Honeywell 24 VAC
 Used on most Hydro Tek NG & LP machines.
 Powered by BGG15 Ignition Module
 P/N BGV07
Conversion to LP
 P/N BGV08

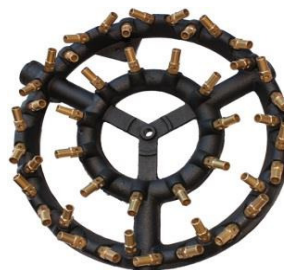

Burner ring with Jets
 with Natural Gas jets
 P/N BGW70
 with Liquid Propane jets
 P/N BGW72



Miscellaneous Burner & Coil Parts

BURNERS & COILS



A2VA-7116 Fuel Pump
Used on almost all Hydro Tek Diesel Fired Machines
P/N BPA10



Clean-Cut Fuel Pump
110 VAC /SM
P/N BPA13
Clean-Cut Fuel Pump with Integrated Fuel Valve
110 VAC w/PD Timer
P/N BPA15
220 VAC
P/N BPA16



Fuel Valves
12 VDC Fuel Valve
P/N BPV02
110 VAC Fuel Valve
P/N BPV10
220 VAC Fuel Valve
P/N BPV20



Fuel Valve Coils
Includes Wire & Plug
12 VDC Coil, green
P/N BPV15
110 VAC Coil, gray
P/N BPV14
220 VAC Coil, black
P/N BPV19



High Pressure Manifold
Used on many Hydro Tek machines. Includes 3) 1/2" and 2) 3/8" ports. Ideal for installing pop-off, thermostat or dual gun setup.
(replaces the hex manifold P/N HHA01)
P/N HHA10



Racor Fuel Filter / Water Separator
P/N BF020
Replacement Element
P/N BF025 - call for quantity discount



Inline Fuel Filter 1/4"
P/N BF015



Fiberfrax Insulation Blanket
24" x 25' x 1/2"
P/N BN053

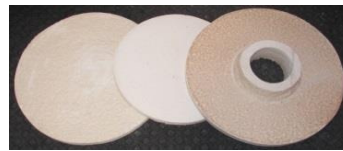

Insulation Discs
Disc 14.33" x 1"
P/N BN049
Disc with 4" Hole 18"
P/N BN054
Disc 18" Exhaust Side
P/N BN109
Disc 18" x 1.5" thick blanket
P/N BN055

Fuel Nozzles

P/N	SIZE	P/N	SIZE
BZ101	1.00 90W	BZ250	2.50 80B
BZ135	1.35 80B	BZ255	2.50 80A
BZ150	1.50 80B	BZ276	2.75 90B
BZ175	1.75 80B	BZ300	3.00 90B
BZ200	2.00 80B	BZ301	3.00 90A
BZ225	2.25 80B	BZ326	3.25 80A
BZ226	2.25 80A	BZ350	3.50 90B
BZ227	2.25 90A	BZ400	4.00 90B



Red Devil Soot Remover

Improves burner efficiency. Directions on can. Large 32oz. can
P/N CB200



Descaler

Used to remove mineral and soap deposits from heating coils. Instructions included. Sulfamic acid, 8 pound container.
P/N CB100

Heating Coil Protection

Protect heating elements by removing debris or minerals from inlet water. The universal bracket and filter housing kit attaches to most 1"-1 1/2" tubing to fit most pressure washer frames, then choose the filter insert that will most benefit you.



- A 10-micron filter cartridge removes debris, ideal when using well water, sandy or non-potable water.
- The anti-scale cartridge removes minerals to prevent scale buildup.

P/N AF001, cartridge housing and bracket
P/N VFH11, 10-micron cartridge
P/N VFD50, scale inhibitor cartridge

Coil Lifting Tool

Lift horizontal coils more steady & securely with the coil lifting tool.
P/N ASC07



NOZZLE CAPACITIES: U.S. Gallons per Hour No. 2 Fuel Oil								
Rate gph @ 100psi	Operating Pressure: Pounds per square inch							
	125	140	150	175	200	250	275	300
0.40	0.45	0.47	0.49	0.53	0.56	0.63	0.66	0.69
0.50	0.56	0.59	0.61	0.66	0.71	0.79	0.83	0.87
0.60	0.67	0.71	0.74	0.79	0.85	0.95	1.00	1.04
0.65	0.73	0.77	0.80	0.86	0.92	1.03	1.08	1.13
0.75	0.84	0.89	0.92	0.99	1.06	1.19	1.24	1.30
0.85	0.95	1.01	1.04	1.13	1.20	1.34	1.41	1.47
1.00	1.12	1.18	1.23	1.32	1.41	1.58	1.66	1.73
1.10	1.23	1.30	1.35	1.46	1.56	1.74	1.82	1.91
1.20	1.34	1.42	1.47	1.59	1.70	1.90	1.99	2.08
1.25	1.39	1.48	1.53	1.65	1.77	1.98	2.07	2.17
1.35	1.51	1.60	1.65	1.79	1.91	2.14	2.24	2.34
1.50	1.68	1.77	1.84	1.98	2.12	2.37	2.49	2.60
1.65	1.84	1.95	2.02	2.18	2.33	2.61	2.73	2.86
1.75	1.96	2.07	2.14	2.32	2.48	2.77	2.90	3.03
2.00	2.24	2.37	2.45	2.65	2.83	3.16	3.32	3.46
2.25	2.52	2.66	2.74	2.98	3.18	3.56	3.73	3.90
2.50	2.80	2.96	3.06	3.30	3.54	3.95	4.15	4.33
3.00	3.35	3.55	3.68	3.97	4.24	4.74	4.97	5.20
3.50	3.91	4.14	4.29	4.63	4.95	5.53	5.80	6.06
4.00	4.47	4.73	4.90	5.29	5.66	6.32	6.63	6.93
4.50	5.04	5.32	5.51	5.95	6.36	7.11	7.46	7.79
5.00	5.59	5.92	6.13	6.61	7.07	7.91	8.29	8.66
5.50	6.15	6.51	6.74	7.27	7.78	8.70	9.12	9.53
6.00	6.71	7.10	7.33	7.94	8.49	9.49	9.95	10.39

DRIVE COMPONENTS & MOTORS



P/N	BELT
KSA28	5L280
KSA30	5L230
KSA32	5L250
KSA33	5L240
KSA34	5L260
KSB29	BX29
KSB30	BX30
KSB32	BX32
KSB34	BX34
KSB35	BX35
KSB36	BX36
KSB38	BX38
KSB39	BX39
KSB4X	BX40
KSB42	BX42
KSB44	BX44
KSB45	BX45
KSG27*	270 x 1.5 * Gear Belt



P/N	Bushing Size
KSG16	G1 x 1
KSH12	H 3/4
KSH14	H 7/8
KSH15	H 16.5MM
KSH19	H 24MM
KSP16	P1 x 1



P/N	Sheave Size	O.D."
KT036	BK36H	3.75
KT040	BK40H	3.95
KU100	2BK100H	9.75
KV038	3TB38	4.15
KHG16**	16 x 1.50	** Gear Belt Pulley
KHH30**	30 x 1.50	** Gear Belt Pulley

(We sell many more sheaves, belts and bushings. Please call if you aren't able to find what you need.)

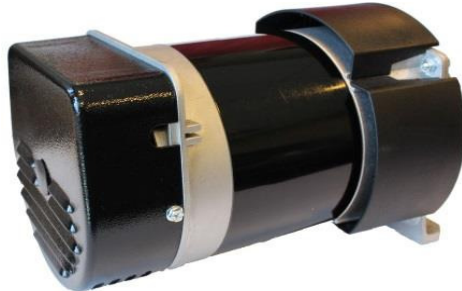

Hydro Tek Generator

Water resistant construction (IP23). Top mounted control box. Includes capacitor. 2900 watt. 22MM Shaft / 3600 RPM. P/N MB034 (NEW Fall 2014)

Brush repair kit for Voltmaster 3000 watt generator sold June 2012 to Fall 2014
P/N MB026

Capacitors

Capacitor 16MFD for Leroy-Somers, pre May 2012 generators
P/N MB025
Capacitor 25MF replacement for Voltmaster June 2012 to Fall 2014
P/N MB022
Capacitor for brushless generator Fall 2014 to current
P/N TBD



EISA CERTIFIED
EISA CERTIFIED

P/N	HP	RPM	VAC	PHASE	FRAME	SHAFT	
ME201	1.5	3450	110	1	56C	5/8	TEFC
ME202	1.5	1725	110	1	56C	5/8	ODP
ME203	2	1800	115/208/230	1	56C	5/8	ODP
ME205	2	3450	115/208/230	1	56C	5/8	ODP
ME504	5	3450	208/230	1	56C	3/4	ODP
ME606	6.5	3450	230	1	56C	3/4	ODP
ME800	8	1745	208/230	1	215T	1 3/8	ODP
ME772	7.5	1760	208-230/460	3	213T	1 3/8	ODP
ME903	10	1750	200-230/460	3	215T	1 3/8	ODP



HONDA
ENGINES



VANGUARD

KOHLER
ENGINES



Kubota



ENGINES & ENGINE PARTS

P/N	CC	MODEL	START	AMPS	SHAFT SIZE	MUFFLER
MH056	160	GC160	Pull	0	3/4	Included
MH135	389	GX390	Electric	10	1	Included
MH230	688	GX630	Electric	17	1	Optional
MH270	688	GX690	Electric	17	1 1/8	Optional
MS065	205	Vanguard	Pull / Electric	20	3/4	Included
MS090	305	Vanguard	Pull	20	1	Included
MS145	479	Vanguard	Electric	16	1	Included
MS180	570	Vanguard	Electric	20	1	Included
MS210	627	Vanguard	Electric	20	1	Included
MS290	896	Vanguard	Electric	20	1 1/8	Included
MKU10	442	KD440	Electric	20	Diesel - 1	Included
MK270	725	CH740	Electric	15	1 7/16	Included
MU168	599	D602	Electric	40	Diesel - 1 1/8	Included
MU120	719	D722	Electric	14	Diesel - 1 1/8	Included

Hydro Tek model and serial number required to order these replacement engines.

Bolt-on Exhaust Elbow with Rain Cap

Fits 599cc and 719cc Kubota Diesel

P/N MKH02

Fits 725cc and 747cc Kohler and 627cc Vanguard

P/N MKV02



Bolt-on Exhaust Elbow with Rain Cap

Fits Vanguard 479cc & 570cc belt drive configurations

P/N MS158

For 479cc Vanguard direct drive configurations (not pictured)

P/N MS164

Clamp to attach exhaust elbow to muffler

P/N FD118

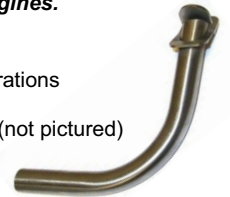

Choke Cable, 6'

P/N HL216



Briggs & Stratton Engine Service Parts



Key Switch w/keys

Used on Vanguard & Kohler Engines

P/N EC165

Extra/Replacement key set

P/N MS175



Fuel Pump

fits 13 - 31hp

P/N MS186



Muffler Exhaust

fits 13 - 21hp

Oil filter side (shown)

P/N MS155

Starter side

P/N MS156



Air Filter

fits most 13 - 18hp

P/N MS183

fits most 21 & 31hp

P/N MS211

Oil Filter

fits all Vanguard V-Twin

P/N MS185



Fuel Filter

fits all V-Twin

P/N 845125



Starter Solenoid

Fits 6.5hp, 13 - 21hp

P/N MS178



Spark Plug

Fits most 6.5 - 31hp

P/N MS174

Muffler gasket for MS155

P/N MS154

Kohler Engine Service Parts



Air Filter

P/N MK510 (for CH18-22)

Precleaner

P/N MK515 (for CH18-22)

Oil Filter

P/N MK500 (for CH11-15)

P/N MK400 (for CH18-22)



Spark Plugs

CH18-25

P/N MK570



Key switch & Harness

For larger Kohler engines used on Hydro Tek machines with remote mount key switch

4-Wire - P/N ESS08

5-Wire - P/N ESS07



Starters

CH18-25

P/N MK605

Kubota Engine Service Parts



Air Filter

P/N MU203 (for Z482B-1)

P/N MU163 (for D905/D1005)



Oil Filter

P/N MU202 (for Z482B-1)

P/N MU167 (for D905/D1005)



Key Switch

fits most Kubotas

P/N MU300



Fuel Filter

P/N MU201 (for ZB600)

P/N MU201 (for Z482B-1)

P/N MU177 (for D905/D1005)

Honda Engine Service Parts



Muffler Exhaust-Custom

Stays cooler, built in heat shields

fits MH230 and MH270

P/N MH688



Oil Filter

fits MH230 and MH270 engine

P/N MH232

We sell many more engine maintenance parts. Please call if you don't see what you need.

TANKS & FITTINGS



Fuel Tanks

Tanks do not include fuel caps, bushings or elbows.



Fuel Tank 4-Gallon
Red P/N WT036
Black P/N WT037



Fuel Tank 8-Gallon
Red P/N WT07R
Clear P/N WT075
Non-permeable, CARB approved, black tank P/N WT08N (not shown)



Fuel Tank 18-Gallon
Clear P/N WT078
Red P/N WT08R



Fuel Caps
Gas P/N WT081
Diesel P/N WT080
Blank P/N WT082



Ratcheted with tether, non-vented
Gas - CARB approved P/N WT08G
Diesel P/N WT08D



Cap & gauge, non-vented, tethered
P/N WT8GA



Fuel Labels

4" x 1.6"
Gasoline (red) P/N GLL10
Diesel (yellow) P/N GLL20



Fuel Fittings

Bushing 1/4" P/N DFF04
Fuel tank Ell P/N DFE04
Dip Tube P/N DF599
Bushing requires .495 - .500 hole
Drilled tanks cannot be returned



Fuel Tank Straps

Field replacement stainless bands with turnbuckles to field replace worm gear style straps P/N HFC10



Hydro Tek Float Tanks

All float tank assemblies are 4-gallon and feature a 1/4" spin-weld nut in each corner for easy mounting. Assemblies include GHA, float valve, dual filtration, lid and discharge fitting for 5/8" hose. Call with model number & serial number for exact configuration.

P/N WT046 (most models)



Float Tank parts

Float Valve P/N VVF08
Tank Cap stainless P/N HH400
Raw 4gal Tank P/N WT040
Bushing 5/8" P/N DFF10
Screen Filter P/N D0021
GH Washer P/N D0020
Tube Strainer P/N VF050



Water Tank, 8 gallon
Natural, poly P/N WT08P
(while supplies last)

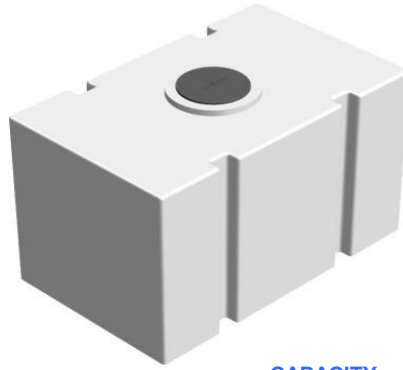

TANKS & FITTINGS



Bulk Water Tanks

Made from seamless linear polyethylene. Tanks include a 10" 1/4-turn fill lid (except 70 gal tank). Straps / Brackets / Plumbing not included with raw tank. Ships by truck.

CAPACITY	L / W / H	P/N
70 black	48 / 25 / 13	WT069
200	48 / 29 / 34	WT201
200 black	48 / 29 / 34	WT202
270	48 / 34 / 41	WT265
270 black	48 / 34 / 41	WT267

Bulk Water Tank Straps

You won't need to create a tie down strap, we've done it already. The steel hold down straps are fabricated to fit these tanks securely and aesthetically. Simply bolt straps down to your flat trailer. Straps are sold individually, two straps required for new install.

- For 200 gallon tanks Strap P/N HCS20
- For 270 gallon tanks Strap P/N HTS03
- For 270 gallon tanks tandem mount Strap P/N HTS05

Bulk Water Tank Plumbing Parts

The big 1-1/2" Poly plumbing allows for a rapid-dump gate valve, greater filtration and a water supply for even the larger flow 12gpm equipment.

- Valve 1-1/2" P/N VVB10
- Tee 1-1/2" P/N DAT15
- Nipple 1-1/2" P/N D2150
- Filter 1-1/2 180micron P/N VF150
- Bushing 1-1/2" P/N D1615
- Hose Barb 3/4" P/N D8120



- For 3/4" plumbing
- Bulkhead 3/4" P/N DFT12
- Street Ell 3/4" P/N D5612
- Filter 3/4" 200micron P/N VF125
- Coupler 3/4" P/N D3120
- Hose Barb 3/4" P/N D8120



Tank Lids

Tank Lid 8" with red insert
Full threaded lid
P/N WT304



Tank Lid 10" non-threaded
1/4 turn keyed lid
P/N WT010

IN / OUT	BOWL	MICRON	P/N
3/4 MPT	Black	200	VF125



Filter Elements for VF125

Black	80	VF130
White	200	VF140
Blue	300	VF131



Filter Flush Valve for VF125

IN / OUT	MICRON	P/N
1 1/2 FPT	180 Black	VF150



Used on most Hydro Tek Trailers since 2006

1 1/2 FPT	180	Clear bowl	VF15C
-----------	-----	------------	-------



Wear Parts for VF150
Screen 180M P/N VF153
O-Ring P/N VF151



Garden Hose Adaptors

IN	OUT	BYPASS	P/N
3/4 FGH	1/2 MPT	1/4	100651



IN	OUT	BYPASS	P/N
3/4 FGH	1/2 MPT	N/A	100275
3/4 FGH	1/2 FPT	N/A	100276
3/4 FGH	3/8 MPT	N/A	100277



IN	OUT	BYPASS	P/N
1/2 FPT	1/2 MPT	2 x 1/4F	ZMFIL / VF085



This is a sample of the top selling fittings.
Additional brass and poly fittings are also available.

HOSE REELS & SWIVELS

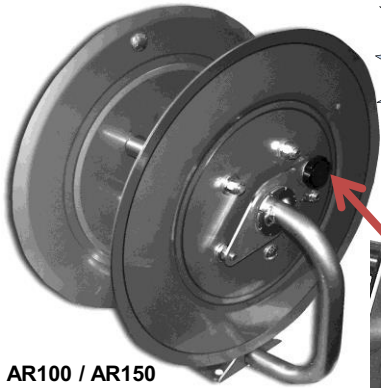

AR100 / AR150



▪ Ship Quick ▪ Already Assembled ▪



Stainless Steel Reel for a Painted Price

These Hydro Tek Engineered and manufactured hose reels boast ratings up to 5000PSI and 400F. The universal mounting foot means you can bolt it almost anywhere. The 5000PSI versions are built with a Super Swivel and includes a Zerk fitting for prolonged life. A unique friction brake allows for near infinite drag settings and also prevents free-spooling. Why pay for a painted reel when you can have a stainless steel reel for about the same cost? Fluid path and mounting foot are zinc plated steel.

3/8" x 150' / 3500PSI / 250°F P/N AR100

3/8" x 150' / 5000PSI / 400°F P/N AR150

5/8" x 150' / Inlet P/N AR152*

3/8" x 250' / 3500PSI / 250°F P/N AR110*

3/8" x 250' / 5000PSI / 400°F P/N AR151*

*AR110, AR151, AR152 have pop-pin brake

NEW - AR152 now with 1/2" swivel

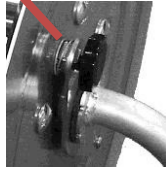

Unique friction brake allows for precise drag settings



Stainless Steel Wall Mount Reel

3/8" x 100' / 5000PSI / 400°F P/N AR188

Includes wall bracket



AR110 / AR151 / AR152

Pop-pin lock keeps hose securely wound on reel

Stacking Hose Reels

Two stainless hose reels attached to a sturdy powder coated steel frame that conveniently bolts down to any flat surface.

Two configurations to choose from:

Part# AR325 has reel capacities of 250' x 3/8", 5000psi, 400° paired with a 150' inlet reel with 1/2" swivel.

Part# AR326 has reel capacities of 250' x 3/8", 5000psi, 400° paired with another of the same.

Ships in two boxes, install top reel to stacking bracket.



Pivoting Hose Reel, wall mount or machine mount



Have a look at the AR425 pivoting hose reel. The stainless reel has a capacity of 150' x 3/8", 5000psi, 400° and is designed to mount on tubing with the enclosed clamp, or can be mounted on a wall. The reel has a friction brake for adjusting the drag depending on your job. It will pivot a full 360 degrees or you can slide the pin to lock the rotation where needed.

(hose and gun sold separately)

3/8"x150' / 5000PSI / 400°F P/N AR425



Replacement Latch

Heavy duty spring latch Used on Hydro Tek hose reels until mid 2010 P/N HL095



Replacement knob/handle

Nub style hose reel handle. Used on Hydro Tek hose reels P/N HL009



Replacement pop-pin

Pop-pin latch Used on Hydro Tek hose reels P/N FP150



Stainless Swivel 5000 PSI / 200F

3/8F x 3/8F P/N 7044



High Flow Swivel - Brass

1/2"M x 1/2"F
3625psi / 42 gpm
P/N DR050



Long Life Swivel 5070 PSI / 300F

Nickel plated brass, stainless internal
3/8M x 3/8F P/N DR053 / 200301025



Replacement Delrin Bearing

2) Per Hydro Tek hose reel. Two Delrin bearings per hose reel receiver also P/N HL050



Nickel Plated Swivels 90 Degree

The best in the industry. 5000 PSI / 400F Max Includes a Zerk fitting for easy service and increased life. High temperature Aflas seals.

3/8M x 3/8F P/N DR058 / 9SS8MP38XFP38

1/2M x 1/2F P/N DR056 / 9SS8MP50XFP50

3/8F x 3/8F P/N DR054 / 9SS8FP38XFP38

1/2F x 1/2F P/N DR057 / 9SS8FP50XFP50

Repair Kit P/N DR059 / SS-KIT-AL



Brass Swivel 3000 PSI / 300F

3/8M x 3/8F Brass
P/N DR055 / 7030



Hydro Tek Surface Cleaner Swivels

Nickel Plated 4000 PSI / 4-10 GPM

200F / 2000 RPM

P/N VAM04

Repair Kit P/N VAM00



Anodized aluminum housing, brass bearing shaft, stainless bearings.

5000psi / 3 - 6 GPM

190F / 3200 RPM

P/N VA004

Bearing Repair kit P/N VA005

Nozzle Repair kit P/N VA006



MISCELLANEOUS

Spot Free DI Filters

Resin filter insert pack for Hydro Tek Spot Free DI washers Sold as a pair
P/N VFD25 Call for pricing, quantity discounts available



Wheels & Tires

5 x 13" 3/4" Bearing
P/N HT127
3/4" Collar
P/N HC012
5/8" Acorn Nut
P/N FNA09



Panel Hardware

J-Nut 5/16" P/N FJ518
T-Screw 5/16" P/N FA508
Retainer 5/16" P/N FA505
Self capture nut 1/4", 12g P/N FNS03
Self capture nut 1/4", 16g P/N FNS04
Self capture nut 1/4", 18g P/N FNS05
Stainless panel screws:
1/2"Lx 5/16" P/N FB509
3/4"L x 5/16" P/N FB511



Hand Grips

Fits on 1" O.D. Tubing
P/N HL010



Casters

3" diameter P/N HT300

Pump Mounting Hardware

Mounting Bolt Short P/N HPR60
Mounting Bolt Long P/N HPR61
Adj Bolt 2-1/2" P/N FB641
Lock Nut 5/16" P/N FNJ06
Washer 5/16" P/N FWC05



EZ Align Pump Rails

P/N HCS11 (used on some SC-gas and some CPS)
P/N HCS12 (used on belt drive HD & SS, all HN, and most SC-gas & CPS)



Pump Rails

Fits Cat FR-5, 3CP, 5CP, 7CP, AR North America XW & RK
P/N HPR01



Pump Rails

Fits Cat 5 Frame & 5CP Pumps
P/N HHD03



Pump Rails

Fits Cat FR-7, FR-15, AR North America RK, XW, General Pump HTF & T SERIES 47
P/N HPR07



Pump Rails

Fits Cat 5CP and AR North America XW & RK Series Pumps
P/N HPR10



Swing up Jacks

Bolt-on with 8" wheel. Fulton
1500# capacity
P/N TJ130

Bolt-on with 6" wheel. Fulton
1000# capacity
P/N TJ120



Stop & Tail Light

Oval, Curbside or Street side. Fits in oval cutout-non bolt-on.
P/N TL500
LED P/N TL501

Wire Harness 20' 4-lead

Four pole flat receptacle, 20', P/N TLW20
7-way plug with 12' wire harness, P/N TLRP2
Most rental yards offer tow vehicle hookup assistance/instructions.

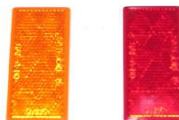

Side Reflectors with Adhesive backing

Amber (front) P/N TLR83
Red (rear) P/N TLR84



Torsion Axles 3700 # / 5-Lug 60"

Idle P/N TAR37
Electric P/N TAR38
Surge P/N TAR39



Tires & Wheels 5-Lug

175-80 13" Grey P/N TTA13
205-75 14" Grey P/N TTA14
205-75 14" Chrome P/N TTC14



Coupler for 2" Ball, Fits 3" tongue

5000# Class III, P/N TC235
6000# Class IV, P/N TC260



Coupler for 2-5/16" Ball, Fits 3" tongue

12,000#, Class IV, P/N TC230



Surge Coupler for 2" Ball, Fits 3" tongue

6000#, Class III
P/N TH060

Hydro Twister® Rotary Surface Cleaners

The Hydro Twister® Series are industrial flat-surface cleaners that connect to a pressure washer and use a spray bar rotating at a high speed within 1" of the ground. It will clean concrete more consistently than an operator with a wand, with less fatigue, 10-20 times faster, and use less water. Hydro Twister surface cleaners can be used with cold water or up to 250° hot water, on some models, for extra stubborn grease or grime, eliminating the need for soap pretreatment in most applications.

- Low profile deck will fit under benches & machinery
- Low maintenance because of stainless permanently lubricated & sealed bearings
- Stainless rotary arms for durability and rust resistance
- Hose is protected inside stainless handle tubing
- Less fatigue because handle is held in place at ideal working angle
- Rustproof and heavy duty for daily use
- New Rear splash guard to keep operator's feet dry

Available in 20" (P/N ANT21, ANT1N)
28" (P/N ANT28, ANT4C) cleaning path and a
24.5"/30" (P/N ANTV5) or 12" (P/N ANT12) recovery twister

See the accessory video online at:
<http://www.hydrotek.us/accessories.htm>



Wastewater and Flood Recovery Vacuums

Capture and transfer up to 3000 gallons of water per hour with the compact RPV vacuum system. Features a powerful, industrial 2-stage vacuum motor. A heavy duty stainless steel pump transfers wastewater up to 100' away while vacuuming continues...no need to stop and dump the collection tank. It is ideal for interior and exterior facilities maintenance contractors who need to collect wash water or for restoration contractors who need to pick up large volumes of water after a fire or flood. Increase your efficiency with optional vacuum tools or even a Twister Vacuum® that can be used with these Hydro Tek recovery vacuums. Meets EPA and storm drain regulations by collecting water before entering storm drains. (For use with cold water or hot water up to 200F)

Looking for a high-powered, dry, shop vacuum? Add the optional dry work filter (P/N VFBB3) and vacuum accessories to your RPV and you have an incredibly high-powered dry vacuum. Ideal for a building service contractor or a professional auto detailer.

Recover and transfer 30gpm - 115v, 15 amp or 3500w generator P/N RPV30E1
Recover and transfer 50gpm - 115v, 20 amp or 5000w generator P/N RPV50E1

See the Hydro Vac video online at: <http://www.hydrotek.us/recycle.htm>



Optional wheel kits

Hot Link, Hot Water Generator

The Hot Link attaches to your existing cold water pressure washer to give you the power of hot water to quickly melt away grease and grime. The cold water pressure washer provides high pressure water into the Hot Link which heats the water before delivering it through the spray gun and wand. The Hot Link is flow controlled; when the gun is pulled, the burner automatically starts and stops when the gun is released. Simply attach the Hot Link to almost any cold water pressure washer using the included jumper hose, then connect the pressure washer's hose, gun/wand and nozzles to the outlet on the Hot Link

12v DC Powered, Diesel heated P/N CPHL5DC
115v Powered, Diesel heated P/N CPHL5E1



Low Impact, High Reach Sprayer

The High Reach Sprayer is ideal for cleaning surfaces with water and chemicals that are not tolerant of the impact of a high pressure washer. Cleaning algae and mold off rooftops, siding, and sidewalks is quick and efficient with this compact self contained sprayer. The AC110 sprays up to 40 feet high so you can avoid the hazards of ladders and scaffolding. The key behind the high reach 12 volt pump is the low restriction hose, swivel and gun that do not degrade the pressure at the spray nozzles like others do. It is also equipped with a wide angle nozzle and angled wand to deliver an even spray application to surfaces that are within easy reach. Requires 2) 6V batteries
P/N AC110





Filter Housing & Parts
20" x 4.5" 1" Inlet & Outlet
Double o-ring seal
P/N VFH08
Replacement O-Ring
P/N VFH03
Filter Wrench
P/N VFW04



Filters
Pleated Carbon, 20" x 4.5"
10 Micron, P/N VFH10

Pleated Polyester
10 Micron, 20" x 4.5", P/N VFH12
10 Micron, 10" x 4.5", P/N VFH11
20 Micron, 20" x 4.5", P/N VFH07

String Wound Filter, 20" x 4.5"
call for quantity discount
20 Micron, P/N VFH25
50 Micron, P/N VFH50



Filter Bags 7" Diameter
Will hang from the Adaptor Head (HSS24)
P/N VFB05 5 Micron 32"
P/N VFB10 100 Micron 32"
P/N VFB45 800 Micron inner strainer bag
P/N VFB8S 800 Micron debris catcher, 16"
P/N VFB40 400 Micron
P/N VFB41 Duo-Flow Dirt Bag, 26", 400 micron
mesh top, 100 micron bottom
P/N VFBB3 8.5" x 9.5" cylindrical dry work filter bag
for RPV(sold as a 3 pack)



Adapter Head 1.5" Plastic
1.5" FPT Inlet
Used to suspend many of the filter
bags above
P/N HSS24



Replacement Filter Basket Strainer
12" x 9.5", 1000 micron, used on AZV/RZV
P/N VFBS2
8" x 9.5", 1000 micron, used on RPV
P/N VFBS8



Hydro Carbon Absorption Pillow
40 Pound capacity, 18" x 6"
call for quantity discount
P/N VB040



Universal Hydrocarbon Absorption Sock
4' x 3" / Filled with recycled cellulose
P/N ZMAT5



Gate Valve 1-1/2"
Used on most Hydro Tek built recovery
systems and trailers. Allows for quick
dumping of sludge and/or water
P/N VVB10



Vacuum Motor
Motor is 2-stage, 5.7" 110-120v, 9amp
P/N MEV15



Transfer Pump
12VDC 17.4PSI / 21.0 GPM / Flooded inlet
All Stainless Steel head and wetted parts
P/N PS135

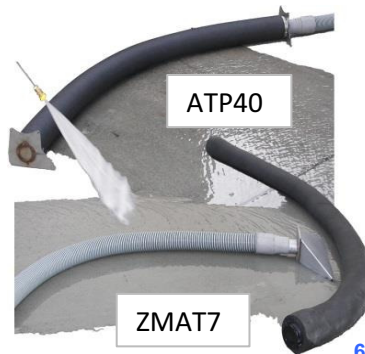

5' Hydro Vacuum Arch

Perhaps the easiest way to recover water today. Lay it on the ground, connect a vacuum system (75 - 200 CFM) via 2" hose and go to work. It's designed to work with all of our 2" vacuum recovery and flatwork systems. Manufactured using all corrosion resistant stainless steel inserts and supports. Covered and sealed with high-grade closed cell foam material. This system creates a vacuum wall along the bottom edge and draws the effluent run off up from the ground for capture. Suitable for concrete or asphalt with 5' wide even surface.
P/N ATP40

6' Hydro Dike Water Containment Berm

This is one of the best damming systems on the market with its ability to conform to surfaces with bends or uneven terrain because of its pliable, rubberized composition. Use several for a complete containment barrier or even to line them up and direct water towards your pickup device. Shown with vacuum hose and scupper (not included). Each berm is 6' long and requires approximately 20lbs. of small pea gravel
P/N ZMAT7



Stainless Steel Scupper

Heavy Duty, Stainless Steel pickup device and is heavy enough to stay put.
Fits 1.5" vacuum hose, 6" wide, P/N ATP64
Fits 2" vacuum hose, 12" wide, P/N ATP75



Sand Bag Dam

Stainless steel closure on both ends to easily fill partially with sand - sand not incl.
2' P/N ZMAT2
10' P/N ZMAT6

Hydro Vacuum Accessory Bundle

One start-up bundle, many uses. Includes the following:
25' vacuum hose and 50' vacuum hose
Scupper
Qty 2) 10' sand berms
Hydro Dike berm
Squeegee tool
Aluminum carpet wand
Dry work filter pack
Bundle P/N ASF10

Vacuum Hose, Heavy duty, Ribbed

2" x 50' vacuum hose w/ cuffs, P/N DHV50
2" x 25' vacuum hose w/ cuffs, P/N DHV25
2" hose, sold per foot, P/N DHV02
Cuffs for 2" hose, P/N DHV05
Connector for 2" hose, P/N DHV51
2" to 1 1/2" adaptor, P/N VVV61



Portable Wash Pad 12' x 25' x 2"

For larger containment needs, use a wash pad. 2" high foam filled sides contain the water. Wash pad sets up in 3 minutes and is light enough to fold up and move to the next job. Includes protective undermat. (other sizes and types available)
P/N ZBPAD

Submersible Sump Pump 1/4 HP

115 VAC / Max flow 48 GPM / 1/4 Horse Power / Float operated with Automatic Reset Thermal Overload.
P/N PS106

Submersible Sump Pump 3/4 HP

115 VAC / Max flow 57 GPM / 3/4 Horse Power / Automatic Reset Thermal Overload.
P/N PSG50

Submersible Sump Pump 1/3 HP

115 VAC / Max flow 38 GPM / 1/3 Horse Power / Float operated with Automatic Reset Thermal Overload.
P/N PSG13



PUMPS



MFGR	MODEL	GAS	ELECTRIC	SOLID	RPM	PSI	GPM	UNL	SIZE	F
CAT	2DX20ES / P1502		5/8 56C		3450	2000	2	Yes	3	140
CAT	3CP1120 / P4022			16.5MM	1725	2200	4.2		5.5	160
CAT	5CP3120 / P4535			20MM	1645	3500	4.5		5	160
CAT	56 / P6056			24MM	1210	3500	5.5		5.88	160



MFGR	MODEL	GAS	ELECTRIC	SOLID	RPM	PSI	GPM	UNL	SIZE	F
AR	RCV2.5G27D-F7 / PH275	3/4			3400	2700	2.5		3	140
AR	RCV3.5G25D-F8 / PH325	3/4			3400	2500	3.5		4.5	140
AR	RRV3.5G36D-F24 / PH356	1			3400	3600	3.5		3.5	140
AR	RCA2G22E-F8 / PH222		5/8		1750	2200	2		5.5	140
AR	RCV3G25E-F8 / PH32E		3/4 56C		3400	2500	3		4	140
AR	XW21.28 / PH407			24MM	1450	4060	5.55		5.5	140
AR	RK15.28HN / PH411 (RH) PH406 (LH)			24MM	1450	4000	3.96		4	140
AR	RK1828-HN / PH475			24MM	1450	4000	4.75		4.5	140



MFGR	MODEL	GAS	ELECTRIC	SOLID	RPM	PSI	GPM	UNL	SIZE	F
GP	EZ4040G / PG404	1			3400	4000	4		4	165
GP	EP1813S17 / PG422			24MM	1750	2900	4.2		5	165
GP	TX1813S17 / PG350			24MM	1750	2500	4.1		5.5	165
GP	TS2021 / PG563			24MM	1125	3500	4.5		5	165
GP	TSF2021 / PG585			24MM	1450	3600	7		7.5	165
GP	TSF2021 / PG585			24MM	1750	3600	8.5		9	165
GP	TSP1821 / PG590			24MM	1450	5000	5.5		5	165

The above pumps are the most commonly sold. We sell many more pumps, please call if you don't see what you need.





General Pump Oil / Hyd Non-Detergent 30WT
 16 OZ Bottle P/N 100295 / PGL16
 16 OZ Bottle 6-Pack P/N 100214
 16 OZ Bottle 24-Pack P/N 100216
 2.5 Gallon x 2 (Total 5-Gallon) P/N 100553



Cat Pump Oil / Hyd Non-Detergent 30WT
 21 OZ Bottle P/N 6107 / PL100

PUMP REPAIR KITS

PUMP	MFG P/N	VALVE KIT 1)/REQUIRED	PISTON OIL SEAL /REQUIRED	SEAL KIT 1)/REQUIRED	SEAL KIT W/BRASS 3)/REQUIRED	PISTON /REQUIRED
 General Pump Kits						
PG350	TX1813S17	K123	K159 / 1	K44	K167	44040109 / 3
PG404	EZ4040G	K123	K23 / 1	K153	K156	44040266 / 3
PG422	EP1813S17	K269	K271 / 1	K274	K277	58040209 / 3
PG563	TS2021N	K01	K02 / 1	K69	K28	47040409 / 3
PG585	TSF2021	K169	90162500 / 3	K171	K170	66040309 / 3
PG590	TSP1821	K15066	90162500 / 3	K180	K176	66040309 / 3
 AR Pump Kits						
PH32E	RCV3G25E-F8	AR2186	AR42474 / 1	AR42476	x	AR42475 / 1
PH407	XW21.28	AR2780	AR2781 / 1	AR2278	x	AR2288 / 1
PH411 / PH406	RK1528HN	AR2864	AR1855 / 1	AR1857	x	AR2546 / 1
PH475	RK1828HN	AR2864	AR1855 / 1	AR1887	x	AR2547 / 1
PH222	RCA2G22E-F8	AR2186	AR42474 / 1	AR42469	x	AR42467 / 1
PH275	RCV2.5G27D-F7	AR2186	AR42474 / 1	AR42476	x	AR42475 / 1
PH325	RCV3.5G25D-F8	AR2186	AR42474 / 1	AR42476	x	AR42475 / 1
PH356	RRV3.5G36D-F24	AR1828	AR42555 / 1	AR42556	x	AR42556 / 1
 Cat Pump Kits						
P1502	2DX20ES	33057	47215 / 3	33053	x	542403 / 3
P4022	3CP1120	33062	46839 / 3	33983	x	46976 / 3
P4535	5CP3120	33060	46838 / 3	33629	x	46884 / 3
P6056	56	33820	43228 / 3	30799	x	43232 / 3

The kits listed here are the most common sellers. Many more kits are available. Contact customer service for more information if you don't see the kit you need.

Hydro Tek's Conversion Chart

Directions: Fill in lines A-D and then work out formulas below

*** CETA Standard +/- 5%**

A	PSI	
B	GPM	
C	Desired Temperature Rise	
D	Nozzle Distance From Surface (Inches)	
E	Nozzle Size	$\text{SQRT}(4000/A) \times B$
F	Cleaning Units	$A \times B$
G	Required Gas HP Belt Drive*	$(A \times B) / 1014$
H	Required Gas HP Gear Drive*	$(A \times B) / 1024$
I	Required Gas HP Direct Drive*	$(A \times B) / 1045$
J	Required Electric HP Belt Drive*	$(A \times B) / 1446$
K	Required Electric HP Direct Drive*	$(A \times B) / 1491$
L	Required Diesel HP*	$(A \times B) / 1250$
M	Required Hydraulic HP*	$(A \times B) / 1714$
N	Required BTU	$B \times 8.3453 \times 60 \times C \times 1.2$
O	Required Diesel #2 (GAL / HR)	$N / 140,000$
P	Required Kerosene (GAL / HR)	$N / 130,200$
Q	BAR	$A \times .06803$
R	Liter / Minute	$B \times 3.78$
S	LBS / Water per Minute	$B \times 8.3453$
T	Theoretical Impact (LBS)	$\text{SQRT}(A) \times B \times .0526$
U	Theoretical Nozzle Coverage 15 Deg	$D \times .26$
V	Theoretical Nozzle Coverage 25 Deg	$D \times .44$
W	Theoretical Nozzle Coverage 40 Deg	$D \times .73$
X	Theoretical Nozzle Coverage 65 Deg	$D \times 1.27$

List Pricing - effective August 12, 2014 (pricing subject to change without notice)

Part Number	Price	Part Number	Price	Part Number	Price
7044	\$ 53.57	AL324	\$ 14.04	BGW72	\$ 304.59
30530	\$ 142.80	AL325	\$ 22.04	BM017	\$ 5.28
30799	\$ 294.00	ANS04	\$ 104.00	BM018	\$ 79.64
100214	\$ 49.16	ANS55	\$ 104.00	BM019	\$ 1.91
100216	\$ 184.44	ANT12	CALL	BM020	\$ 41.20
100275	\$ 8.99	ANT1N	CALL	BM030	\$ 4.42
100276	\$ 9.69	ANT21	CALL	BM035	\$ 3.81
100277	\$ 9.22	ANT28	CALL	BM156	\$ 57.82
100438	\$ 59.94	ANT4C	CALL	BM159	\$ 2.06
100439	\$ 59.94	ANTV5	CALL	BM160	\$ 12.88
100538	\$ 59.94	AR100	\$ 249.00	BM161	\$ 14.79
100651	\$ 27.26	AR110	\$ 299.00	BM275	\$ 27.74
105120	\$ 23.75	AR150	\$ 290.00	BM276	\$ 30.72
105121	\$ 23.75	AR151	\$ 325.00	BM289	\$ 35.48
105122	\$ 23.75	AR152	\$ 325.00	BM513	\$ 167.81
105123	\$ 23.75	AR1855	\$ 63.83	BM514	\$ 165.59
105124	\$ 23.75	AR188	\$ 415.00	BM554	\$ 202.59
105125	\$ 23.75	AR1887	\$ 143.25	BM556	\$ 118.69
105126	\$ 23.75	AR21669	\$ 159.74	BM562	\$ 200.85
845125	\$ 6.30	AR2186	\$ 40.92	BM563	\$ 199.59
44040266	\$ 138.48	AR2278	\$ 159.21	BMC13	\$ 283.25
47040509	\$ 75.69	AR2288	\$ 250.14	BMC15	\$ 117.19
58040209	\$ 50.17	AR2546	\$ 187.71	BMC20	\$ 25.75
66040309	\$ 103.82	AR2547	\$ 194.82	BMC40	\$ 47.07
070000180	\$ 14.10	AR325	\$ 810.00	BME10	\$ 21.07
070000220	\$ 30.78	AR326	\$ 810.00	BMT02	\$ 227.50
070000230	\$ 31.12	AR42467	\$ 49.74	BMT04	\$ 145.00
90162500	\$ 3.13	AR42469	\$ 50.02	BMT10	\$ 120.25
200357170	\$ 47.70	AR42474	\$ 32.00	BMT12	\$ 202.58
200357535	\$ 89.28	AR42475	\$ 33.09	BMT13	\$ 132.87
200357540	\$ 89.28	AR42476	\$ 33.72	BMT18	\$ 81.24
200357545	\$ 89.28	AR425	\$ 375.00	BMT20	\$ 132.59
200357550	\$ 89.28	AR42555	\$ 13.25	BN049	\$ 31.93
200357560	\$ 89.28	AR42556	\$ 56.07	BN053	\$ 144.20
200457555	\$ 149.00	ASB40	\$ 399.00	BN054	\$ 29.87
202605600	\$ 55.27	ASB55	\$ 399.00	BN055	\$ 30.90
2141GXB3000	\$ 24.00	ASC07	\$ 153.47	BN109	\$ 25.75
2141GXB5000	\$ 24.00	ASF10	\$ 749.00	BPA10	\$ 126.69
2141GXB6000	\$ 24.00	ASH06	\$ 1,340.00	BPA13	\$ 150.00
2240GXB3000	\$ 27.00	ATP40	\$ 310.00	BPA15	\$ 144.20
2240GXB5000	\$ 27.00	ATP64	\$ 81.37	BPA16	\$ 144.20
2240GXB6000	\$ 27.00	ATP75	\$ 95.00	BPV02	\$ 63.49
2440-UC	\$ 5.20	AVUN1	\$ 85.00	BPV10	\$ 59.74
3CP1120.3	\$ 1,002.00	AVW20	\$ 280.00	BPV14	\$ 16.48
8107.2213.00	\$ 31.68	AVW6B	\$ 145.00	BPV15	\$ 19.47
900__M	\$ 5.15	AVWD1	\$ 365.00	BPV19	\$ 16.48
900__Q	\$ 5.15	BC144	\$ 669.50	BPV20	\$ 59.74
900__S	\$ 5.15	BC300	\$ 1,143.30	BU007	\$ 776.62
915__M	\$ 5.15	BC316	\$ 1,225.00	BU013	\$ 808.96
915__Q	\$ 5.15	BC335	\$ 1,499.68	BU023	\$ 1,092.00
915__S	\$ 5.15	BC445	\$ 2,018.80	BU600	\$ 792.07
925__M	\$ 5.15	BC480	\$ 870.61	BU602	\$ 817.80
925__Q	\$ 5.15	BC484	\$ 793.10	BU605	\$ 694.18
925__S	\$ 5.15	BC788	\$ 1,019.70	BZ101	\$ 8.30
940__M	\$ 5.15	BC789	\$ 1,714.70	BZ135	\$ 8.30
940__Q	\$ 5.15	BF015	\$ 7.32	BZ150	\$ 8.30
940__S	\$ 5.15	BF020	\$ 79.00	BZ175	\$ 8.30
965400M	\$ 4.61	BF025	\$ 32.00	BZ200	\$ 8.30
965400Q	\$ 3.54	BGG15	\$ 181.59	BZ225	\$ 8.30
AC110	CALL	BGP10	\$ 42.32	BZ226	\$ 8.30
AC340	\$ 75.00	BGT10	\$ 22.50	BZ227	\$ 8.30
AC380	\$ 75.00	BGV07	\$ 180.61	BZ250	\$ 8.30
AC440	\$ 1,525.00	BGV08	\$ 13.41	BZ255	\$ 8.30
AF001	\$ 165.00	BGV09	\$ 10.00	BZ276	\$ 8.30
AG100	\$ 110.00	BGW36	\$ 21.12	BZ300	\$ 8.30
AL323	\$ 12.45	BGW70	\$ 304.59	BZ301	\$ 8.30

List Pricing - effective August 12, 2014 (pricing subject to change without notice)

Part Number	Price	Part Number	Price	Part Number	Price
BZ326	\$ 13.00	DHB10	\$ 2.27	EM305	\$ 40.16
BZ350	\$ 13.00	DHB12	\$ 2.94	EM312	\$ 45.00
BZ400	\$ 13.00	DHB17	\$ 3.65	EM313	\$ 45.00
CB100	\$ 52.00	DHB18	\$ 4.79	EM601	\$ 40.16
CB200	\$ 30.00	DHC80	\$ 2.03	EM603	\$ 40.16
CPHL5DC	CALL	DHL12	\$ 2.98	EP115	\$ 90.64
CPHL5E1	CALL	DHP04	\$ 3.53	EP120	\$ 128.75
D0020	\$ 0.21	DHS08	\$ 2.71	EP125	\$ 231.75
D0021	\$ 0.76	DHV02	\$ 4.08	EP240	\$ 844.80
D10001	\$ 4.62	DHV05	\$ 8.24	ESS07	\$ 97.85
D10002	\$ 4.62	DHV25	\$ 110.00	ESS08	\$ 98.88
D10003	\$ 5.72	DHV50	\$ 185.00	EWB06	\$ 77.25
D10004	\$ 5.72	DHV51	\$ 10.42	EWB10	\$ 153.47
D10006	\$ 1.88	DR050	\$ 37.19	EWCO8	\$ 3.09
D10007	\$ 1.88	DR053	\$ 20.89	EWC10	\$ 5.15
D10008	\$ 1.88	DR054	\$ 87.55	EWC12	\$ 9.27
D10009	\$ 1.88	DR055	\$ 70.59	EWL16	\$ 1.60
D10021	\$ 3.71	DR056	\$ 97.85	EWL20	\$ 1.13
D10022	\$ 3.21	DR057	\$ 91.67	EWL25	\$ 1.13
D10023	\$ 3.37	DR058	\$ 61.80	EWL30	\$ 1.13
D10024	\$ 3.37	DR059	\$ 17.51	EWN08	\$ 0.82
D10027	\$ 6.06	DWSDBTK	\$ 206.19	EWN12	\$ 0.82
D10028	\$ 5.09	EA053	\$ 175.10	EWN16	\$ 1.55
D10029	\$ 6.06	EA054	\$ 156.64	FA505	\$ 0.48
D10030	\$ 5.64	EA103	\$ 205.00	FA508	\$ 2.05
D10072	\$ 7.42	EC110	\$ 56.86	FB509	\$ 2.52
D10073	\$ 7.42	EC115	\$ 1.03	FB511	\$ 2.52
D10074	\$ 10.46	EC160	\$ 16.24	FB641	\$ 0.77
D10075	\$ 10.46	EC165	\$ 32.00	FD118	\$ 5.31
D10076	\$ 3.36	EC170	\$ 116.84	FJ518	\$ 1.59
D10077	\$ 3.10	EC260	\$ 140.13	FNA09	\$ 1.03
D10078	\$ 4.50	EC405	\$ 20.69	FNJ06	\$ 0.25
D10079	\$ 4.50	EC406	\$ 16.48	FNS03	\$ 0.62
D1615	\$ 5.98	EC410	\$ 16.48	FNS04	\$ 0.62
D2150	\$ 5.84	EC411	\$ 16.48	FNS05	\$ 1.44
D3120	\$ 6.53	EC420	\$ 16.48	FP150	\$ 14.16
D5612	\$ 6.39	EC421	\$ 16.48	FV006	\$ 62.03
D8120	\$ 4.83	EC450	\$ 19.39	FWC05	\$ 0.10
DAT15	\$ 16.49	EC490	\$ 5.77	GLL10	\$ 4.07
DF599	\$ 7.00	EC495	\$ 5.77	GLL20	\$ 4.07
DFE04	\$ 2.99	EC498	\$ 5.77	HB050	\$ 24.00
DFF04	\$ 0.91	EC499	\$ 3.08	HB100	\$ 24.00
DFF10	\$ 2.06	ECC01	\$ 24.72	HB101	\$ 25.00
DFT12	\$ 17.51	ECC05	\$ 12.36	HC012	\$ 4.64
DH003	\$ 14.26	ECC07	\$ 39.14	HCS11	\$ 45.00
DH006	\$ 24.50	ECC08	\$ 28.84	HCS12	\$ 45.00
DH007	\$ 24.90	ECC10	\$ 119.32	HCS20	\$ 70.00
DH008	\$ 25.35	ECC12	\$ 32.96	HFC10	\$ 29.87
DH014	\$ 37.08	ECC20	\$ 131.01	HH400	\$ 7.21
DH015	\$ 42.23	ECC21	\$ 48.00	HHA10	\$ 50.47
DH020	\$ 43.26	ECC40	\$ 189.02	HHD03	\$ 71.07
DH025	\$ 47.38	ECD10	\$ 56.65	HL009	\$ 4.66
DH026	\$ 14.97	ECD20	\$ 56.65	HL010	\$ 3.08
DH027	\$ 61.81	ECD24	\$ 51.50	HL050	\$ 1.03
DH032	\$ 17.77	ECD25	\$ 80.34	HL095	\$ 15.40
DH034	\$ 19.29	ECF03	\$ 14.94	HL216	\$ 13.79
DH050	\$ 81.00	ECF05	\$ 28.84	HLB09	\$ 0.56
DH057	\$ 88.00	ECF10	\$ 14.94	HPR01	\$ 29.51
DH060	\$ 120.00	ECF15	\$ 14.94	HPR07	\$ 66.95
DH095	\$ 151.00	ECH50	\$ 43.26	HPR10	\$ 27.81
DH097	\$ 166.00	ECH55	\$ 41.54	HPR60	\$ 6.17
DH098	\$ 225.00	ECH70	\$ 8.23	HPR61	\$ 8.23
DH200	\$ 15.79	ECH72	\$ 8.23	HSS24	\$ 57.65
DH426	\$ 62.11	ECT05	\$ 159.65	HT127	\$ 40.17
DHB04	\$ 0.77	ECT06	\$ 148.32	HT300	\$ 11.10
DHB08	\$ 1.24	EF025	\$ 32.57	HTS03	\$ 175.00

List Pricing - effective August 12, 2014 (pricing subject to change without notice)

Part Number	Price	Part Number	Price	Part Number	Price
HTS05	\$ 226.54	MK270	\$ 3,115.35	PGK30	\$ 71.20
K15066	\$ 302.76	MK400	\$ 15.59	PGK40	\$ 65.69
K153	\$ 129.57	MK500	\$ 15.28	PGK44	\$ 68.85
K159	\$ 27.64	MK510	\$ 17.00	PGK51	\$ 56.96
K167	\$ 75.46	MK515	\$ 8.23	PGK88	\$ 73.84
K169	\$ 219.27	MK570	\$ 11.47	PGK97	\$ 27.41
K170	\$ 172.96	MK605	\$ 377.81	PGL16	\$ 7.69
K171	\$ 127.43	MKH02	\$ 73.18	PH222	\$ 362.56
K176	\$ 130.50	MKU10	\$ 4,967.55	PH275	\$ 362.56
K180	\$ 211.24	MKV02	\$ 70.70	PH325	\$ 362.56
K269	\$ 66.96	MS065	\$ 718.94	PH32E	\$ 362.56
K271	\$ 24.35	MS090	\$ 793.10	PH356	\$ 465.97
K274	\$ 81.98	MS145	\$ 1,450.24	PH406	\$ 635.54
K277	\$ 62.06	MS154	\$ 8.00	PH407	\$ 1,047.48
K44	\$ 46.32	MS155	\$ 155.02	PH411	\$ 635.54
K69	\$ 101.30	MS156	\$ 297.67	PH475	\$ 674.26
KHG16	\$ 49.44	MS158	\$ 34.34	PHK06	\$ 86.50
KHH30	\$ 87.55	MS164	\$ 36.05	PHK20	\$ 57.62
KSA28	\$ 8.48	MS174	\$ 7.57	PHK30	\$ 112.25
KSA30	\$ 12.60	MS175	\$ 12.37	PHK34	\$ 48.93
KSA32	\$ 7.43	MS178	\$ 45.31	PHK36	\$ 89.67
KSA33	\$ 9.91	MS180	\$ 1,931.25	PHK40	\$ 60.13
KSA34	\$ 12.35	MS183	\$ 24.43	PHK58	\$ 128.30
KSB29	\$ 18.89	MS185	\$ 18.53	PHK61	\$ 60.67
KSB30	\$ 22.65	MS186	\$ 58.71	PHK62	\$ 136.63
KSB32	\$ 17.13	MS210	\$ 2,214.50	PHK64	\$ 128.91
KSB34	\$ 15.09	MS211	\$ 27.81	PL100	\$ 14.25
KSB35	\$ 15.09	MS290	\$ 3,084.85	PP061	\$ 84.75
KSB36	\$ 15.54	MU120	\$ 10,070.55	PP215	\$ 6.36
KSB38	\$ 21.34	MU163	\$ 87.22	PP228	\$ 10.32
KSB39	\$ 17.05	MU167	\$ 15.90	PP232	\$ 148.80
KSB42	\$ 18.75	MU168	\$ 8,380.51	PP262	\$ 139.20
KSB44	\$ 16.36	MU201	\$ 15.28	PP263	\$ 90.00
KSB45	\$ 19.33	MU202	\$ 15.69	PP305	\$ 91.20
KSB4X	\$ 19.56	MU203	\$ 35.98	PP306	\$ 84.75
KSG16	\$ 10.71	MU300	\$ 99.07	PP330	\$ 182.40
KSG27	\$ 39.99	NB095	\$ 150.72	PP402	\$ 69.60
KSH12	\$ 9.56	NR040	\$ 135.17	PP629	\$ 174.75
KSH14	\$ 9.56	NR055	\$ 135.17	PP683	\$ 11.28
KSH15	\$ 9.07	NT040	\$ 149.00	PP752	\$ 58.08
KSH19	\$ 9.07	NT055	\$ 149.00	PP82A	\$ 177.60
KSP16	\$ 22.54	NT060	\$ 149.00	PP838	\$ 11.40
KT036	\$ 30.90	NT070	\$ 149.00	PP884	\$ 76.80
KT040	\$ 30.90	OR-110EPDM70	\$ 0.26	PP983	\$ 108.75
KU100	\$ 75.34	OR-110VT75	\$ 0.46	PS106	\$ 215.00
KV038	\$ 47.38	OR-112EPDM70	\$ 0.26	PS120	\$ 285.00
MB022	\$ 86.52	OR-112VT75	\$ 0.46	PS125	\$ 320.00
MB025	\$ 52.53	P1502	\$ 516.00	PS135	\$ 610.00
MB026	\$ 162.00	P4022	\$ 831.00	PSG13	\$ 239.00
MB034	\$ 799.00	P4535	\$ 978.00	PSG50	\$ 469.00
ME201	\$ 414.68	P6056	\$ 1,659.00	PULSAR4KHP	\$ 90.02
ME202	\$ 398.61	PG350	\$ 516.11	RPV30E1	CALL
ME203	\$ 534.78	PG404	\$ 607.93	RPV50E1	CALL
ME205	\$ 458.35	PG422	\$ 608.71	TAR37	\$ 531.48
ME504	\$ 623.15	PG563	\$ 904.19	TAR38	\$ 853.87
ME606	\$ 880.00	PG585	\$ 1,353.37	TAR39	\$ 871.87
ME772	\$ 1,131.97	PG590	\$ 1,893.70	TC230	\$ 286.06
ME800	\$ 1,508.95	PGK01	\$ 66.79	TC235	\$ 48.41
ME903	\$ 1,328.70	PGK02	\$ 10.47	TC260	\$ 75.19
MEV15	\$ 178.27	PGK03	\$ 23.64	TH060	\$ 378.53
MH056	\$ 608.67	PGK07	\$ 17.89	TJ120	\$ 64.89
MH135	\$ 1,722.00	PGK08	\$ 69.86	TJ130	\$ 155.00
MH230	\$ 2,886.00	PGK15	\$ 131.14	TL500	\$ 19.57
MH232	\$ 17.09	PGK21	\$ 72.94	TL501	\$ 27.04
MH270	\$ 3,017.00	PGK23	\$ 81.52	TLR83	\$ 3.59
MH688	\$ 215.00	PGK28	\$ 48.92	TLR84	\$ 3.59

List Pricing - effective August 12, 2014 (pricing subject to change without notice)

Part Number	Price	Part Number	Price	Part Number	Price
TLRP2	\$ 79.31	VFH08	\$ 184.37	YHL45	\$ 26.62
TLW20	\$ 26.11	VFH10	\$ 113.30	YLS12T	\$ 149.35
TTA13	\$ 233.61	VFH11	\$ 45.00	YPRESSWITCH156	\$ 43.24
TTA14	\$ 269.91	VFH12	\$ 58.71	YU831D	\$ 92.66
TTC14	\$ 395.94	VFH25	\$ 32.00	ZBPAD	\$ 1,995.00
UG055	\$ 46.35	VFH50	\$ 32.00	ZMAT2	\$ 20.00
UP045	\$ 26.19	VFW04	\$ 9.95	ZMAT5	\$ 15.44
UP060	\$ 25.20	VG100	\$ 22.82	ZMAT6	\$ 38.00
UP120	\$ 26.78	VG180	\$ 34.66	ZMAT7	\$ 75.00
UP128	\$ 26.78	VG200	\$ 38.72	ZROTOMAX1	\$ 135.17
UP137	\$ 26.78	VG500	\$ 54.79	ZZDBL	\$ 116.81
UPB05	\$ 25.75	VR065	\$ 41.32		
UPB80	\$ 15.00	VR068	\$ 48.29		
UPB85	\$ 49.00	VRT3-250	\$ 92.60		
UPT45	\$ 9.34	VS003	\$ 32.09		
UPT46	\$ 9.34	VS005	\$ 58.93		
UU154	\$ 74.88	VS006	\$ 61.26		
UU260	\$ 81.96	VS007	\$ 61.26		
UU261	\$ 146.82	VS012	\$ 34.94		
UU263	\$ 91.82	VS015	\$ 34.94		
UU268	\$ 74.30	VS025	\$ 127.28		
UU320	\$ 204.39	VS030	\$ 40.63		
UU323	\$ 79.16	VS050	\$ 52.89		
UU370	\$ 158.98	VS051	\$ 7.73		
UU371	\$ 158.98	VS052	\$ 89.92		
UU372	\$ 158.98	VS053	\$ 9.59		
UU373	\$ 158.98	VVB10	\$ 31.52		
UU375	\$ 180.38	VVB38	\$ 65.00		
UU507	\$ 227.48	VVB39	\$ 50.00		
VA004	\$ 215.00	VVC10	\$ 36.05		
VA005	\$ 130.00	VVF08	\$ 36.15		
VA006	\$ 110.00	VW026	\$ 5.67		
VA010	\$ 19.92	VW027	\$ 13.61		
VAM00	\$ 129.19	VW035	\$ 20.05		
VAM04	\$ 314.13	VW036	\$ 12.36		
VB040	\$ 30.85	VW038	\$ 9.27		
VC035	\$ 28.98	VW045	\$ 14.42		
VC037	\$ 28.98	VW048	\$ 12.36		
VF042	\$ 3.71	VWD30	\$ 57.47		
VF045	\$ 14.94	VWD40	\$ 64.73		
VF050	\$ 3.19	VWD42	\$ 79.21		
VF054	\$ 21.13	VWV61	\$ 14.42		
VF055	\$ 20.94	WT010	\$ 22.66		
VF085	\$ 24.82	WT036	\$ 87.55		
VF125	\$ 62.37	WT037	\$ 87.55		
VF130	\$ 38.93	WT040	\$ 63.86		
VF131	\$ 39.69	WT046	\$ 206.00		
VF135	\$ 15.12	WT069	\$ 295.00		
VF140	\$ 39.69	WT075	\$ 113.30		
VF150	\$ 39.14	WT078	\$ 144.20		
VF151	\$ 2.58	WT07R	\$ 113.30		
VF153	\$ 16.46	WT080	\$ 8.23		
VF15C	\$ 78.61	WT081	\$ 8.23		
VFB05	\$ 11.32	WT082	\$ 11.33		
VFB10	\$ 8.24	WT08D	\$ 17.51		
VFB40	\$ 9.22	WT08G	\$ 17.51		
VFB41	\$ 25.75	WT08N	\$ 275.00		
VFB45	\$ 18.54	WT08P	\$ 113.30		
VFB8S	\$ 9.79	WT08R	\$ 144.20		
VFBB3	\$ 65.00	WT201	\$ 430.00		
VFBS2	\$ 59.74	WT202	\$ 548.00		
VFBS8	\$ 59.74	WT265	\$ 585.00		
VFD25	CALL	WT267	\$ 618.00		
VFD50	\$ 175.00	WT304	\$ 79.00		
VFH03	\$ 6.17	WT8GA	\$ 60.77		
VFH07	\$ 56.65	YHL40	\$ 26.62		

INDEX

Adjustable Thermostat	8	Float Tank Assemblies	14
AR Pumps & Parts	20, 21	Float Tanks	14
AR Unloaders	2	Float Tank Parts	3, 14
Awning Wash Pole	1	Float Valves	3, 14
Axle, Trailer	19	Flow Switches	8
		Foam Nozzles	5
Ball Valves	3	Foot Valves	3
Battery Boxes	8	Fuel Filters	11, 13
Beckett Burner & Parts	9, 10, 11	Fuel Nozzles	11
Belts	12	Fuel Pumps	11, 13
Blower Wheels	9, 10	Fuel Solenoids	11
Bolt-On Unloaders	2	Fuel Cap	14
Briggs & Stratton Engines & Parts	13	Fuel Tank	14
Burner Assemblies & Parts	9-11	Fuel Tank Bushing	14
Burner Parts	9-11	Fuel/Water Separators	11
Burst Discs & Adaptors	3	Fuses	7
Bushings & Pulleys	12		
		Garden Hose	6
CAM Switches	7	Garden Hose Adaptors	15
Cat Pump & Parts	20, 21	Gas Cap	14
Check Valves	3	Gas Tank	14
Chemical Injectors	3	Gas Tank Bushing	14
Chemical Metering Valves	3	Gas Valves	10
Chemical Nozzles	4	Gauges	3
Chemical Strainers	3	General Pumps & Parts	20, 21
Chemical Sprayer	5	Generators	12
Circuit Breakers	7	Ground Fault Interrupters	8
Clear Braided Tubing	6	Guns	1
Coil Assemblies	9		
Coil Blanket	11	Hardware	19
Coil Cleaner	11	H-Bushings	12
Coil End Caps	9	Hi Limit Switches	8
Coil, Heater	9	High Pressure Filters	4
Concrete Cleaners	16	Hi Low Nozzles	4
Contactors	7	Honda Engines	13
Containment Berms	17	Hoses	5, 6, 17
Control Set Unloaders	2	Hose Barbs	14
Conversion Charts	11, back	Hose Reel Swivels	18
Couplers, Quick Connect	6	Hose Reels	18
Coupler, Trailer	19	Hour Meters	8
Couplers, Twist Coupler 22MM	6		
Custom Coil Igniter	10	Igniter	9, 10
		Injectors	3
Delrin Bearing	18	Inline Fuel Filters	11
Descaler	11	Ignition Switches	13
Detergent Injectors	3	Inlet Hose	6
Detergent Metering Valves	3	Insulated Wands	1
Detergent Strainers	3	Insulation	11
DI Spot Free Filters	19		
Diesel Cap	14	Jack, Trailer	19
Diesel Tank	14	Jets, Burner ring	10
Dip Tube	14		
Downstream Injectors	3	Kohler Engines & Parts	13
Drain Cleaning Accessories	3		
Drain Pillow	17	Lances	1
Dual Lance	1	Generator	12
		Linear Guns	1
Electric Boxes	8	Magnetic Contactors	7
Electric Motors	9, 10, 12	Magnetic Starters	7
Electronic Ignition, NG & LP	10	Metering Valves	3
Electronic Igniter	9, 10	Molded Grip Lances	1
Engines	13	Motors, Burners	9, 10
Exhaust Ell	13	Motors, Electric	9, 10, 12
Extension Wands	1	Motors, Gas	13
Filters, Oil	13	Muck Scupper	5
Filters, Fuel	11, 13		
Filters, Water	15, 17, 19	Nozzle Chart	Back Cover
Fittings	14, 15	Nozzle Couplers	1
Flex Wands	1	Nozzle Filters	4

Nozzles, High Pressure.....	4	Step-Down Transformers.....	7, 10
Nozzles, Hi Low	4	Storage Tanks, Water.....	15
Nozzles, Low Pressure	4	Strain Reliefs	8
Nozzles, Rotating.....	4	Sump Pump.....	17
Nozzles, Sandblast	5	Suntec Fuel Pumps	11
Nozzles, Soap.....	4, 5	Surface Cleaners.....	16
Oil, Pump.....	20	Surge Coupler	19
ON/OFF Rocker Switch.....	7	Suttner Flow Switches	8
ON/OFF Rotary Switch	7	Suttner Guns	1
ON/OFF Toggle Switch.....	7	Switches, Adjustable Temp.....	8
Open Guns	1	Switches, CAM	7
O-Rings.....	6, 14	Switches, Flow.....	8
Pipe Fittings, Brass, Steel, Poly	15	Switches, Hi-Limit.....	8
Plugs, Quick Connect, Twist Couplers	6	Switches, Pressure	8
Poly-braided Hoses.....	6	Switches, Rocker.....	7
Pop-Off Valves.....	3	Switches, Rotary.....	7
Pressure Relief Valves.....	3	Switches, Toggle	7
Pressure Switches	8	Switches, Vacuum	8
Pressure Gauges	3	Swivels	18
PTP (Pump Thermal Protectors).....	3	Tanks, Float.....	14
Pulleys, Sheaves	12	Tank, Fuel.....	14
Pump Repair Kits	21	Tanks, High Capacity Water	15
Pump, Fuel	11, 13	Tail Lights	19
Pump, High Pressure.....	20	Telescopic Wands	1
Pump Rail	19	Thermal Relief Valves.....	3
Pump Oil.....	20	Thermostat	8
Quick Connect Nozzles.....	4	Timers, Solid State	7
Quick Connects, 22MM (Twist Type)	6	Toggle Switches	7
Quick Connects, Couplers (Socket)	6	Trailer Parts	19
Quick Connects, Plugs.....	6	Transfer Pump.....	17
Racor Fuel Filters.....	11	Transformers, Burners.....	9, 10
Reclaim.....	16, 17	Transformers, Step-Down.....	7, 10
Reels	18	Trigger Guns.....	1
Relays.....	7	Turbo Nozzles	4
Rocker Switches	7	Twist Coupler, 22mm.....	6
Rotary Nozzles.....	4	Undercarriage Cleaner	16
Rotary Switches	7	Unloaders	2
Rotomax Nozzles.....	4	Vacuum Hose	17
Rupture Discs & Adaptors.....	3	Vacuum Switches	8
Sand Blast Assemblies	5	Valves, Ball.....	3
Sand Blast Hoses	5, 6	Valves, Check.....	3
Sand Dam.....	16	Valves, Chemical Metering	3
Sand Nozzles.....	5	Valves, Easy Start	3
Sandblast Heads.....	5	Valves, Float.....	3, 14
Scale Inhibitor	11	Valves, Pressure Relief	3
Screw Couplers, 22mm.....	6	Valves, Thermal Relief.....	3
Scupper	17	Variable Fan Nozzles.....	4
Seals, AR.....	21	Variable Pressure Wands	1
Seals, CAT.....	21	Wands	1
Seals, GP.....	21	Wash Pad	17
Shut-Off Guns.....	1	Water Filters, Low Pressure.....	15, 17, 19
Side Handles	1	Water Filters, Turbo Nozzle	4
Sludge Pump	5	Water Separator, Diesel	11
Soap Nozzles.....	4, 5	Water Tanks	15
Solenoid Valves	11	Wayne Burners & Parts	9, 11
Solid State Time Delay.....	7	Wet-Dry Vac	16
Soot Remover.....	11	Wheels	19
Spray Flex.....	1	Wire Harness, Trailer.....	19
Spray Guns.....	1	Y-Strainers.....	15
Spray Nozzles.....	4, 5		
Sprayer, Chemical	5		
Spot Free – DI Filters.....	19		
Stainless Steel Couplers (Socket).....	6		
Stainless Steel Plug.....	6		

Hydro Tek Nozzle Chart

Nozzle Size	PSI	Flow Rate (GPM)																				Nozzle Size										
		40	75	100	350	500	600	700	800	900	1000	1100	1200	1300	1400	1500	1600	1700	1800	1900	2000		2100	2200	2300	2400	2500	2600	2700	2800	2900	3000
2	0.034	0.20	0.27	0.32	0.59	0.71	0.77	0.84	0.89	0.95	1.00	1.05	1.10	1.14	1.18	1.22	1.26	1.30	1.34	1.38	1.41	1.45	1.48	1.52	1.55	1.58	1.61	1.64	1.67	1.70	1.73	2
2.5	0.039	0.25	0.34	0.40	0.74	0.88	0.97	1.05	1.12	1.19	1.25	1.31	1.37	1.43	1.48	1.53	1.58	1.63	1.68	1.72	1.77	1.81	1.85	1.90	1.94	1.98	2.02	2.05	2.09	2.13	2.17	2.5
3	0.043	0.30	0.41	0.47	0.89	1.06	1.16	1.25	1.34	1.42	1.50	1.57	1.64	1.71	1.77	1.84	1.90	1.96	2.01	2.07	2.12	2.17	2.22	2.27	2.32	2.37	2.42	2.46	2.51	2.55	2.60	3
3.5	0.048	0.35	0.48	0.55	1.04	1.24	1.36	1.46	1.57	1.66	1.75	1.84	1.92	2.00	2.07	2.14	2.21	2.28	2.35	2.41	2.47	2.54	2.60	2.65	2.71	2.77	2.82	2.88	2.93	3.03	3.5	
4	0.052	0.40	0.55	0.63	1.18	1.41	1.55	1.67	1.79	1.90	2.00	2.10	2.19	2.28	2.37	2.45	2.53	2.61	2.68	2.76	2.83	2.90	2.97	3.03	3.10	3.16	3.22	3.29	3.35	3.41	3.46	4
4.5	0.055	0.45	0.62	0.71	1.33	1.59	1.74	1.88	2.01	2.13	2.25	2.36	2.46	2.57	2.66	2.76	2.85	2.93	3.02	3.10	3.18	3.26	3.34	3.41	3.49	3.56	3.63	3.70	3.76	3.83	3.90	4.5
5	0.057	0.50	0.68	0.79	1.48	1.77	1.94	2.09	2.24	2.37	2.50	2.62	2.74	2.85	2.96	3.06	3.16	3.26	3.35	3.45	3.54	3.62	3.71	3.79	3.87	3.95	4.03	4.11	4.18	4.26	4.33	5
5.5	0.060	0.55	0.75	0.87	1.63	1.94	2.13	2.30	2.46	2.61	2.75	2.88	3.01	3.14	3.25	3.37	3.48	3.59	3.69	3.79	3.89	3.99	4.08	4.17	4.26	4.35	4.43	4.52	4.60	4.68	4.76	5.5
6	0.062	0.60	0.82	0.96	1.77	2.12	2.32	2.51	2.68	2.86	3.00	3.15	3.29	3.42	3.55	3.67	3.79	3.91	4.02	4.14	4.24	4.35	4.45	4.55	4.65	4.74	4.84	4.93	5.02	5.11	5.20	6
6.5	0.064	0.65	0.89	1.03	1.92	2.30	2.52	2.72	2.91	3.08	3.25	3.41	3.56	3.71	3.85	3.98	4.11	4.24	4.36	4.48	4.60	4.71	4.82	4.93	5.03	5.14	5.24	5.34	5.44	5.53	5.63	6.5
7	0.067	0.70	0.96	1.11	2.07	2.47	2.71	2.93	3.13	3.32	3.50	3.67	3.83	3.99	4.14	4.29	4.43	4.56	4.70	4.82	4.95	5.07	5.19	5.31	5.42	5.53	5.64	5.75	5.86	5.96	6.06	7
7.5	0.070	0.75	1.03	1.19	2.22	2.65	2.90	3.14	3.35	3.56	3.75	3.93	4.11	4.28	4.44	4.59	4.74	4.89	5.03	5.17	5.30	5.43	5.56	5.69	5.81	5.93	6.05	6.16	6.27	6.39	6.50	7.5
8	0.072	0.80	1.10	1.28	2.37	2.83	3.10	3.35	3.58	3.79	4.00	4.20	4.38	4.56	4.73	4.90	5.06	5.22	5.37	5.51	5.66	5.80	5.93	6.07	6.20	6.32	6.45	6.57	6.69	6.81	6.93	8
8.5	0.074	0.85	1.16	1.34	2.51	3.01	3.29	3.56	3.80	4.03	4.25	4.46	4.66	4.85	5.03	5.21	5.39	5.54	5.70	5.86	6.01	6.16	6.30	6.45	6.58	6.72	6.85	6.98	7.11	7.24	7.36	8.5
9	0.076	0.90	1.23	1.42	2.66	3.18	3.49	3.76	4.02	4.27	4.50	4.72	4.93	5.13	5.32	5.51	5.69	5.87	6.04	6.20	6.36	6.52	6.67	6.82	6.97	7.12	7.26	7.39	7.53	7.66	7.79	9
9.5	0.078	0.95	1.30	1.50	2.81	3.36	3.68	3.97	4.25	4.51	4.75	4.98	5.20	5.42	5.62	5.82	6.01	6.19	6.37	6.55	6.72	6.88	7.05	7.20	7.36	7.51	7.66	7.81	7.96	8.09	8.23	9.5
10	0.080	1.00	1.37	1.58	2.96	3.54	3.87	4.18	4.47	4.74	5.00	5.24	5.48	5.70	5.92	6.12	6.32	6.52	6.71	6.89	7.07	7.25	7.42	7.58	7.75	7.91	8.06	8.22	8.37	8.51	8.66	10
12	0.087	1.20	1.64	1.90	3.55	4.24	4.65	5.02	5.37	5.69	6.00	6.29	6.57	6.84	7.10	7.35	7.59	7.82	8.05	8.27	8.49	8.69	8.90	9.10	9.30	9.49	9.67	9.86	10.04	10.22	10.39	12
15	0.096	1.50	2.05	2.37	4.44	5.30	5.81	6.27	6.71	7.12	7.50	7.87	8.22	8.55	8.87	9.19	9.49	9.78	10.06	10.34	10.61	10.87	11.12	11.37	11.62	11.86	12.09	12.32	12.55	12.77	12.99	15
20	0.109	2.00	2.74	3.16	5.92	7.07	7.75	8.37	8.94	9.49	10.00	10.49	10.95	11.40	11.83	12.25	12.65	13.04	13.42	13.78	14.14	14.49	14.83	15.17	15.49	15.81	16.12	16.43	16.73	17.03	17.32	20
25	0.125	2.50	3.42	3.95	7.40	8.84	9.68	10.46	11.18	11.86	12.50	13.11	13.69	14.25	14.79	15.31	15.81	16.30	16.77	17.23	17.68	18.11	18.54	18.96	19.36	19.76	20.16	20.54	20.92	21.29	21.65	25
30	0.141	3.00	4.11	4.74	8.87	10.61	11.62	12.55	13.42	14.23	15.00	15.73	16.43	17.10	17.75	18.37	18.97	19.56	20.12	20.68	21.21	21.74	22.25	22.75	23.24	23.72	24.19	24.65	25.10	25.54	25.98	30
40	0.156	4.00	5.48	6.32	11.83	14.14	15.49	16.73	17.89	18.97	20.00	20.98	21.91	22.80	23.66	24.49	25.30	26.08	26.83	27.57	28.28	28.98	29.66	30.33	30.98	31.62	32.25	32.86	33.47	34.06	34.64	40

Nozzle Size	PSI	Flow Rate (GPM)																				Nozzle Size										
		40	75	100	350	500	600	700	800	900	1000	1100	1200	1300	1400	1500	1600	1700	1800	1900	2000		2100	2200	2300	2400	2500	2600	2700	2800	2900	3000
2	0.034	1.76	1.79	1.82	1.84	1.87	1.90	1.92	1.95	1.97	2.00	2.02	2.05	2.07	2.10	2.12	2.14	2.17	2.19	2.21	2.24	2.26	2.28	2.30	2.32	2.35	2.37	2.39	2.41	2.43	2.45	2
2.5	0.039	2.20	2.24	2.27	2.30	2.34	2.37	2.40	2.44	2.47	2.50	2.53	2.56	2.59	2.62	2.65	2.68	2.71	2.74	2.77	2.80	2.82	2.85	2.88	2.90	2.93	2.96	2.98	3.01	3.04	3.06	2.5
3	0.043	2.64	2.68	2.72	2.77	2.81	2.85	2.89	2.92	2.96	3.00	3.04	3.07	3.11	3.15	3.18	3.22	3.25	3.29	3.32	3.35	3.39	3.42	3.45	3.49	3.52	3.55	3.58	3.61	3.64	3.67	3
3.5	0.048	3.08	3.13	3.18	3.23	3.27	3.32	3.37	3.41	3.46	3.50	3.54	3.59	3.63	3.67	3.71	3.75	3.79	3.83	3.87	3.91	3.95	3.99	4.03	4.07	4.10	4.14	4.18	4.21	4.25	4.29	3.5
4	0.052	3.52	3.58	3.63	3.69	3.74	3.79	3.85	3.90	3.95	4.00	4.05	4.10	4.15	4.20	4.24	4.29	4.34	4.38	4.43	4.47	4.52	4.56	4.60	4.65	4.69	4.73	4.77	4.82	4.86	4.90	4
4.5	0.055	3.96	4.02	4.09	4.15	4.21	4.27	4.33	4.39	4.44	4.50	4.56	4.61	4.67	4.72	4.77	4.83	4.88	4.93	4.98	5.03	5.08	5.13	5.18	5.23	5.28	5.32	5.37	5.42	5.47	5.51	4.5
5	0.057	4.40	4.47	4.54	4.61	4.68	4.74	4.81	4.87	4.94	5.00	5.06	5.12	5.18	5.24	5.30	5.36	5.42	5.48	5.53	5.59	5.65	5.70	5.76	5.81	5.86	5.92	5.97	6.02	6.07	6.12	5
5.5	0.060	4.84	4.92	5.00	5.07	5.14	5.22	5.29	5.36	5.43	5.50	5.57	5.64	5.70	5.77	5.83	5.90	5.96	6.02	6.09	6.15	6.21	6.27	6.33	6.39	6.45	6.51	6.57	6.62	6.68	6.74	5.5
6	0.062	5.28	5.37	5.45	5.53	5.61	5.69	5.77	5.85	5.92	6.00	6.07	6.15	6.22	6.29	6.36	6.43	6.50	6.57	6.64	6.71	6.77	6.84	6.91	6.97	7.04	7.10	7.16	7.22	7.29	7.35	6
6.5	0.064	5.72	5.81	5.90	5.99	6.08	6.17	6.25	6.34	6.42	6.50	6.58	6.66	6.74	6.82	6.89	6.97	7.05	7.12	7.19	7.27	7.34	7.41	7.48	7.55	7.62	7.69	7.76	7.83	7.89	7.96	6.5
7	0.067	6.16	6.26	6.36	6.45	6.55	6.64	6.73	6.82	6.91	7.00	7.09	7.17	7.26	7.34	7.42	7.51	7.59	7.67	7.75	7.83	7.90	7.98	8.06	8.13	8.21	8.28	8.36	8.43	8.50	8.57	7
7.5	0.070	6.60	6.71	6.81	6.91	7.02	7.12	7.21	7.31	7.41	7.50	7.59	7.69	7.78	7.87	7.95	8.04	8.13	8.22	8.30	8.39	8.47	8.55	8.63	8.71	8.79	8.87	8.95	9.03	9.11	9.19	7.5
8	0.072	7.04	7.16	7.27	7.38	7.48	7.59	7.69	7.80	7.90	8.00	8.10	8.20	8.29	8.39	8.49	8.58	8.67	8.76	8.85	8.94	9.03	9.12	9.21	9.30	9.38	9.47	9.55	9.63	9.72	9.80	8
8.5	0.074	7.48	7.60	7.72	7.84	7.95	8.06	8.18	8.28	8.39	8.50	8.61	8.71	8.81	8.91	9.02	9.12	9.21	9.31	9.41	9.50	9.60	9.69	9.78	9.88	9.97	10.06	10.15	10.24	10.32	10.41	8.5
9	0.076	7.92	8.05	8.17	8.30	8.42	8.54	8.66	8.77	8.89	9.00	9.11	9.22	9.33	9.44	9.55	9.65	9.76	9.86	9.96	10.06	10.16	10.26	10.36	10.46	10.55	10.65	10.74	10.84	10.93	11.02	9
9.5	0.078	8.36	8.50	8.63	8.76	8.89	9.01	9.14	9.26	9.38																						